

# TECHNICAL MANUAL WEIGHT INDICATOR



## E-AF09: PROGRAM VERSION FOR DYNAMIC OR STATIC AXLE WEIGHING WITH INPUT/OUTPUT FUNCTION



LINE 1 HEADER	
LINE 2 HEADER	
LINE 3 HEADER	
....	
VEHICLE: IVECO	
REGISTRATION: 123456	
PLATE: AB123CD	
OPERATOR: ALESSIO	
DATE: 10/10/2010 TIME 14:00	
-----	
AXLE 1:	550kg
AXLE 2:	550kg
AXLE 3:	550kg
AXLE 4:	550kg
-----	
TOTAL	2200kg
-----	

## 3590EKR, 3590EXP, 3590EXT, CPWE, CPWET series indicator



## INDEX

<b>1. REQUIREMENTS FOR AN OPTIMAL INSTALLATION.....</b>	<b>4</b>
1.1 ELECTRICAL PRECAUTIONARY MEASURES .....	4
1.1.1 CABLE CLASSIFICATION.....	5
1.1.2 RECOMMENDED DISTANCES AMONG CABLES.....	5
1.1.3 MAXIMUM CABLE LENGTH .....	5
1.2 EARTHING SYSTEM.....	6
1.3 AXLE WEIGHING SYSTEM INSTALLATION: USEFUL INFORMATION.....	9
<b>2. CONNECTION TO THE LOAD RECEIVER.....</b>	<b>10</b>
2.1 ANOLOG LOAD CELLS .....	10
2.2 DIGITAL LOAD CELLS .....	11
2.2.1 CONNECTION OF LOAD CELLS TO INDICATOR.....	12
2.3.2 C16i DIGITAL CELL CONNECTION .....	13
2.3.3 RCD DIGITAL CELL CONNECTION .....	14
<b>3. SETUP ENVIRONMENT .....</b>	<b>15</b>
ENTER THE PASSWORD SUBSTITUTING THE DISPLAYED (*) RANDOM VALUE .....	15
3.1 SET-UP ENVIRONMENT BLOCK DIAGRAM .....	17
3.2 DESCRIPTION OF THE STEPS .....	23
<< LAnG >> FIRMWARE LANGUAGE.....	23
<< CELtyP >> CELL TYPE.....	23
<< SEtuP >> SCALE CONFIGURATION .....	33
<< diAG. >> DIAGNOSTICS MENU .....	46
3.3 CONFIGURATION OF THE DYNAMIC / STATIC PARAMETERS (STEP << TOTAL >>).....	49
3.4 CALIBRATION OF THE SCALE.....	53
3.4.1 CALIBRATION PROCEDURE .....	53
3.4.2 LINEARIZATION POINTS .....	55
3.4.3 ZONE OF USE DIFFERENT THAN THE ZONE OF CALIBRATION.....	56
3.4.4 QUICK ZERO CALIBRATION.....	56
3.4.5 CELL EQUALISATION PROCEDURE .....	57
3.4.6 ADJUSTMENT OF EQUALIZATION COEFFICIENT.....	57
3.4.7 SETTING THE COMMUNICATION WITH DIGITAL CELLS.....	58
3.4.8 THEORETICAL CALIBRATION.....	59
<b>4. DISPLAY OF THE GEOGRAPHICAL UTILISATION AND CORRECTION ZONE OF THE WEIGHING ERROR DUE TO THE DIFFERENT GRAVITATIONAL ATTRACTION BETWEEN THE CALIBRATION AND UTILISATION ZONE .....</b>	<b>59</b>
4.1 INDICATION AND/OR DISPLAY OF THE GEOGRAPHICAL UTILISATION ZONE (compulsory for the legal type instruments).....	59
4.2 CORRECTION OF THE WEIGHING ERROR INTRODUCED BY A DIFFERENT GRAVITATIONAL ATTRACTION VALUE BETWEEN THE CALIBRATION AND UTILIZATION ZONE (compulsory for the legal type instruments) .....	59
<b>5. SERIAL OUTPUTS .....</b>	<b>60</b>
5.1 RS 485 CONNECTION .....	61
5.2 PC CONNECTION .....	63
5.3 PRINTER CONNECTION.....	63
5.4 TRANSMISSION PROTOCOLS.....	64
5.5 TRANSMISSION MODES .....	66
5.6 SERIAL COMMANDS FORMAT .....	69
5.7 ADVANCED COMMANDS .....	73
5.8 CUSTOMISATION OF THE STRING [available in ComPC e ComPrn].....	80
<b>6. NETWORK MANAGEMENT .....</b>	<b>81</b>
6.1 INSTRUMENT NETWORK CONFIGURATION.....	81
6.2 NETWORK FUNCTIONS .....	82

<b>7. ANALOGUE OUTPUT (OPTIONAL)</b> .....	<b>83</b>
7.1 OPERATING MODES .....	83
7.1.1 OUTPUT ON THE GROSS WEIGHT .....	83
7.1.2 OUTPUT ON THE NET WEIGHT .....	84
7.2 CONFIGURATION .....	85
<b>8. PROGRAMMING THE PRINTOUTS</b> .....	<b>86</b>
8.1 PROGRAMMING EXAMPLE .....	88
8.2 ASCII CODE TABLES .....	89
8.2.1 CODE PAGE 1252 WINDOWS LATIN 1 .....	89
8.2.2 CODE PAGE 1251 WINDOWS CYRILLIC .....	90
8.2.3 CODE PAGE 1253 WINDOWS GREEK .....	91
8.3 LIST OF PRINT BLOCKS .....	92
8.3.1 ORDER BY KIND .....	92
8.3.2 NUMERICAL ORDER .....	99
8.4 BLOCKS WITH PARAMETERS .....	105
<b>9. DISPLAY CUSTOMIZATION</b> .....	<b>113</b>
<b>10. ELECTRICAL SCHEMES</b> .....	<b>114</b>
10.1 MOTHER BOARD .....	114
10.2 I/O EXPANSION BOARD (fitted with 3590EXT in IO version or CPWE) .....	117
10.3 DISPLAY BOARD .....	118
10.4 CONTROL LIGHT .....	118



## **1. REQUIREMENTS FOR AN OPTIMAL INSTALLATION**



To obtain the best results it is recommended to install the indicator and the platform (or transducer) in a place with the following conditions:

**A flat, level surface on which to rest**

**Stable and vibration free**

**No dust or strong vapours**

**No draughts**

**Make sure the platform is level or that the loading cells are resting evenly**

**Moderate temperature and humidity (15-30°C and 40-70%)**

**Do not install anywhere where there is the risk of explosion**

**All the indicator connections have to be made respecting the rules applicable in the zone and in the installing environment. Respect the recommended electrical precautionary measures described in section 1.1.**

**Make sure that the grounding is made correctly, see section 1.2.**

**Everything not expressly described in this manual has to be considered as improper use of the equipment.**

**Avoid welding with load cells installed.**

**Use waterproof sheaths and couplings in order to protect the load cell cables.**

**Use a waterproof junction box to connect the cells.**

### **1.1 ELECTRICAL PRECAUTIONARY MEASURES**

**Mains power supply is restricted to within  $\pm 10\%$  of the rated voltage**

**Electric protections (fuses etc.) are provided by the technician installing the instrument.**

**Respect the recommended minimal distances that are mentioned for the various cable categories, see sections 1.1.1 and 1.1.2.**

**The extension leads of the load cells or signal amplifiers, used for the connection of the serial ports and analogue output must be within the allowed maximum lengths, see section 1.1.3.**

**The extension leads of the load cells or signal amplifiers must be screened. In addition they must be laid on their own in a raceway or metal pipe as far away as possible from the power supply cables.**

**Install "RC" filters on the contactor coils, on the solenoid valves and on all devices producing electric disturbances.**

**If it is possible that condensation could form inside the weight transmitter it is advisable to leave the instrument powered at all times.**

**Every shielded cable or not (for instance PC cable, cell cable, power supply cable) connected to the indicator should be as shorter as possible, then you have to come out of the shield the minimum length of cable, then connect to the terminal box;**

**If the indicator is situated inside an electric panel, the power supply cable should be a shielded cable as shorter as possible, distant from every coil supply cable, inverter, electromotive force, etc. and in addition dedicate an uncoupler transformer in order to feed the indicator only.**

### 1.1.1 CABLE CLASSIFICATION

The various cables are classified depending on the transmitted signals:

#### Category I

- Field bus, LAN (PROFIBUS, Ethernet, Devicenet...)
- Shielded data cables (RS232 ...)
- Shielded cables for analogue/digital signals < 25V (sensors, load cells...)
- Low tension power supply cables (< 60V)
- Coaxial cables

#### Category II

- DC supply cables with tension > 60V and < 400V
- AC supply cables with tension > 25V and < 400V

#### Category III

- Power supply cables with tension > 400V
- Telephone cables

#### Category IV

- Any cable subject to lightning

### 1.1.2 RECOMMENDED DISTANCES AMONG CABLES

- When the cables are laid next to each other, these must be at the distances in the table below
- These distances are valid if in the air; these are reduced if the raceways are separated by grounded metallic shields.
- Different category cables can cross each other (90°)

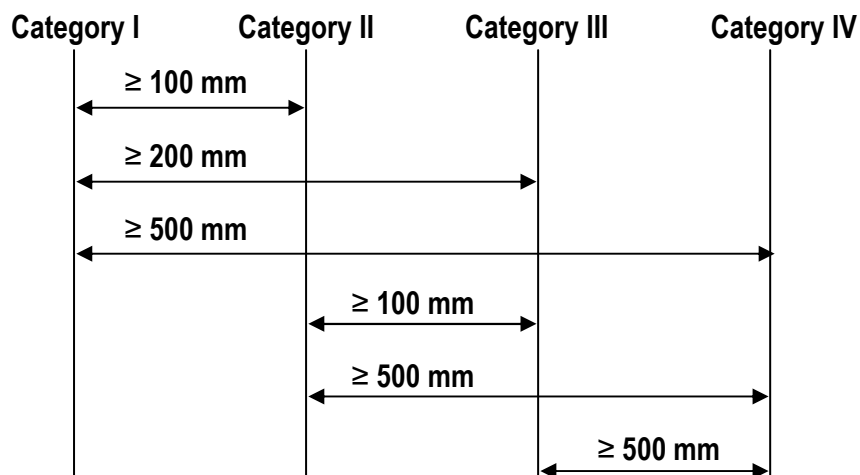

### 1.1.3 MAXIMUM CABLE LENGTH

#### LOAD CELL CABLE

The maximum reachable length from the line using the appropriate load cell cable is:

- 50 m with cable 6 x 0,25 mm<sup>2</sup>
- 100 m with cable 6 x 0,5 mm<sup>2</sup>

#### RS232 CABLE

The maximum reachable length from the line using the RS232 cable with a maximum baud rate of 19200, is about 15 m.

#### RS485 CABLE

The maximum reachable length from the line with the use of the appropriate cable for RS 485 connections (see section 5.1), is about 1200 meters.

## ANALOG OUTPUT CABLE

The maximum length of the analogue output cable in current is:

- 100 m with cable 2 x 0,25 mm<sup>2</sup>
- 150 m with cable 2 x 0,5 mm<sup>2</sup>
- 300 m with cable 2 x 1 mm<sup>2</sup>

The maximum length of the analogue output cable in voltage is:

- 50 m with cable 2 x 0,25 mm<sup>2</sup>
- 75 m with cable 2 x 0,5 mm<sup>2</sup>
- 150 m with cable 2 x 1 mm<sup>2</sup>

## 1.2 EARTHING SYSTEM

For the right earthing and the optimal functioning of the system, it is necessary to connect the indicator, the load cells, the possible junction box and the weighing structure to the earth.

All earthing cables must have the shortest possible length in order to minimize their resistance.

## INDICATOR

Connect the external earthing of the indicator to the earth through copper cables having at least a 16 mm<sup>2</sup> cross-section.

## LOAD CELLS AND JUNCTION BOX

The earthing must be done by connecting the earthing cables to a ground bar with cables having a cross-section of at least 16 mm<sup>2</sup> and by connecting the ground bar to a ground pole with a cable having a cross-section of at least 50 mm<sup>2</sup>.

- In the case the load cells are connected to the indicator through a junction box, it is necessary to connect the sheathing both of cells cables and of indicator cable to the earthing of the junction box (refer to the junction box manual) and connect this to the earth through copper cables having at least a 16 mm<sup>2</sup> cross-section.
- If the load cells are connected directly to the indicator (without the use of the junction box), one should connect the shieldings of the load cell cables to the grounding point (or earthing bar) inside the container.
- If the weighing system concerns large and/or outdoor structures, like weighbridges, and the junction box is connected to the indicator in a distance that is greater than 10 m, or in the presence of noise, the cable shield must be earthed both in the junction box and in the indicator, and the two ground leads must be connected with an earth cable having a cross-section of at least 16 mm<sup>2</sup>.

## WEIGHING STRUCTURE

Connect the weighing structure and the possible connected structures (for example silos that release material on the weighing structure) to the earth through copper cables having at least a 16 mm<sup>2</sup> cross-section.

Furthermore it is necessary that for each cell, one connects the upper part with the lower part of the load cell through a copper braid section not less than 16 mm<sup>2</sup>; the upper part must be short-circuited with the surface of the weighing structure and the lower part must be grounded through a copper braid section not less than 16 mm<sup>2</sup>.

## CONNECTED SERIAL CABLES AND INSTRUMENTS

Connect the shield of the serial cable at the grounding point (or grounding bar) inside the container (on the end of the cable toward the indicator) and at the earth connection of the connected instrument (on the end of the cable toward the indicator), and ground the earth connection of the connected instrument, through a copper cable section not less than 16 mm<sup>2</sup>.

To avoid possible side effects, the earth references of the connection and power supply cable of the indicator and of the connected instrument **must be at the same potential**.

## GENERAL NOTES:

- All the grounding cables must have an adequate length, in order to obtain **an overall resistance of grounding system less than 1  $\Omega$** .
- In the case the weighing system regards great and/or outdoor structures, like weighbridges:
  - The grounding connection is to be made by connecting the grounding cables to a grounding bar and the grounding bar to the grounding pole with a cable section not less than 50 mm<sup>2</sup>.
  - the cable cross-section must be greater (for example 50 mm<sup>2</sup> instead of 16 mm<sup>2</sup> and 100 mm<sup>2</sup> instead of 50 mm<sup>2</sup>), because the voltage into play is greater (for example thunderbolts);
  - the ground pole must be positioned at a distance of at least 10 metres from the weighbridge structure;
  - one needs to open the SENSE inside the indicator in order to offset the drifts due to the increase in temperature.
- One should check and remove, if necessary, the connection between the earth and the neutral wire of the electrical installation.

## EARTHING EXAMPLE WEIGHBRIDGE

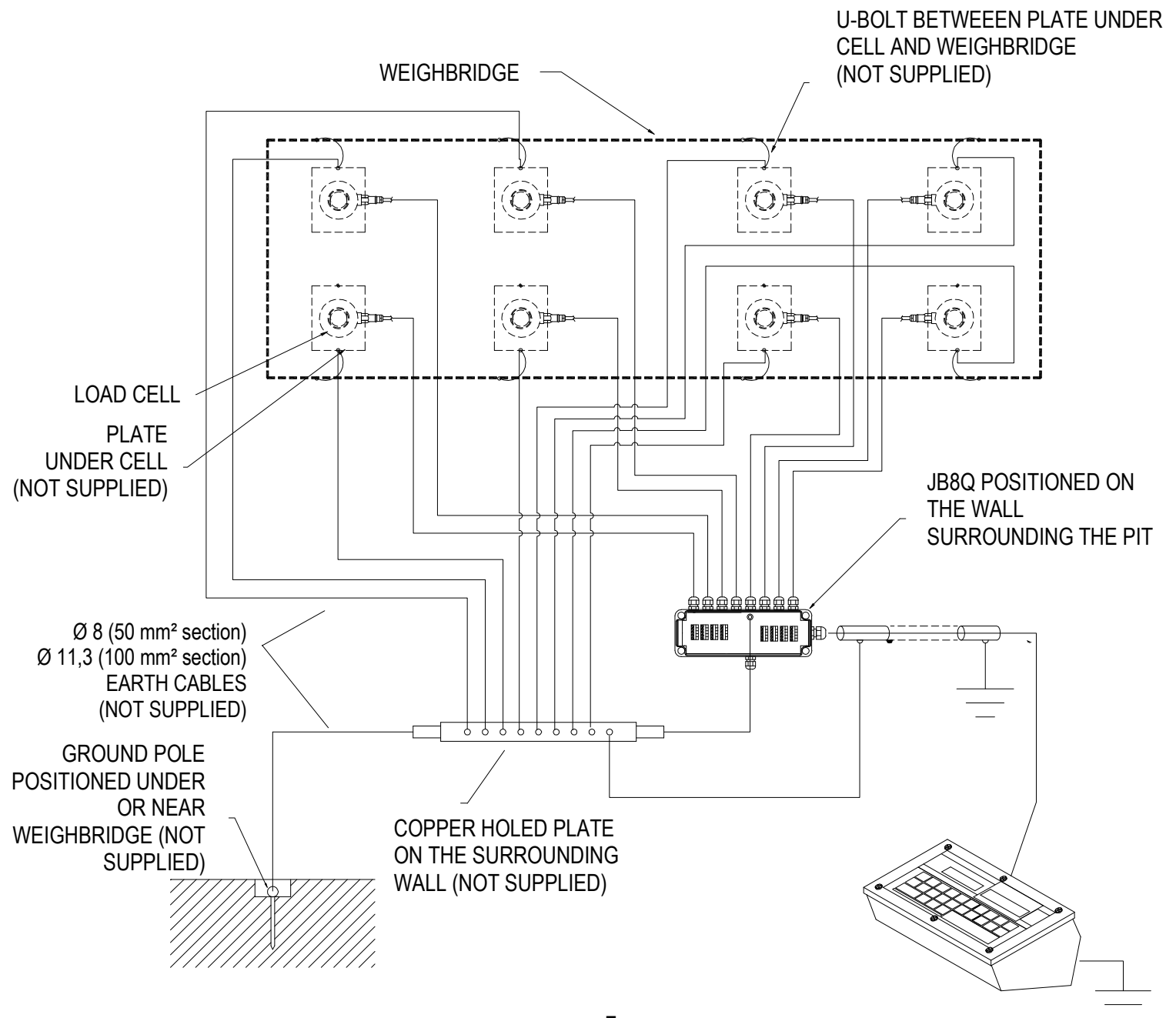

### EARTHING EXAMPLE OF A SILO

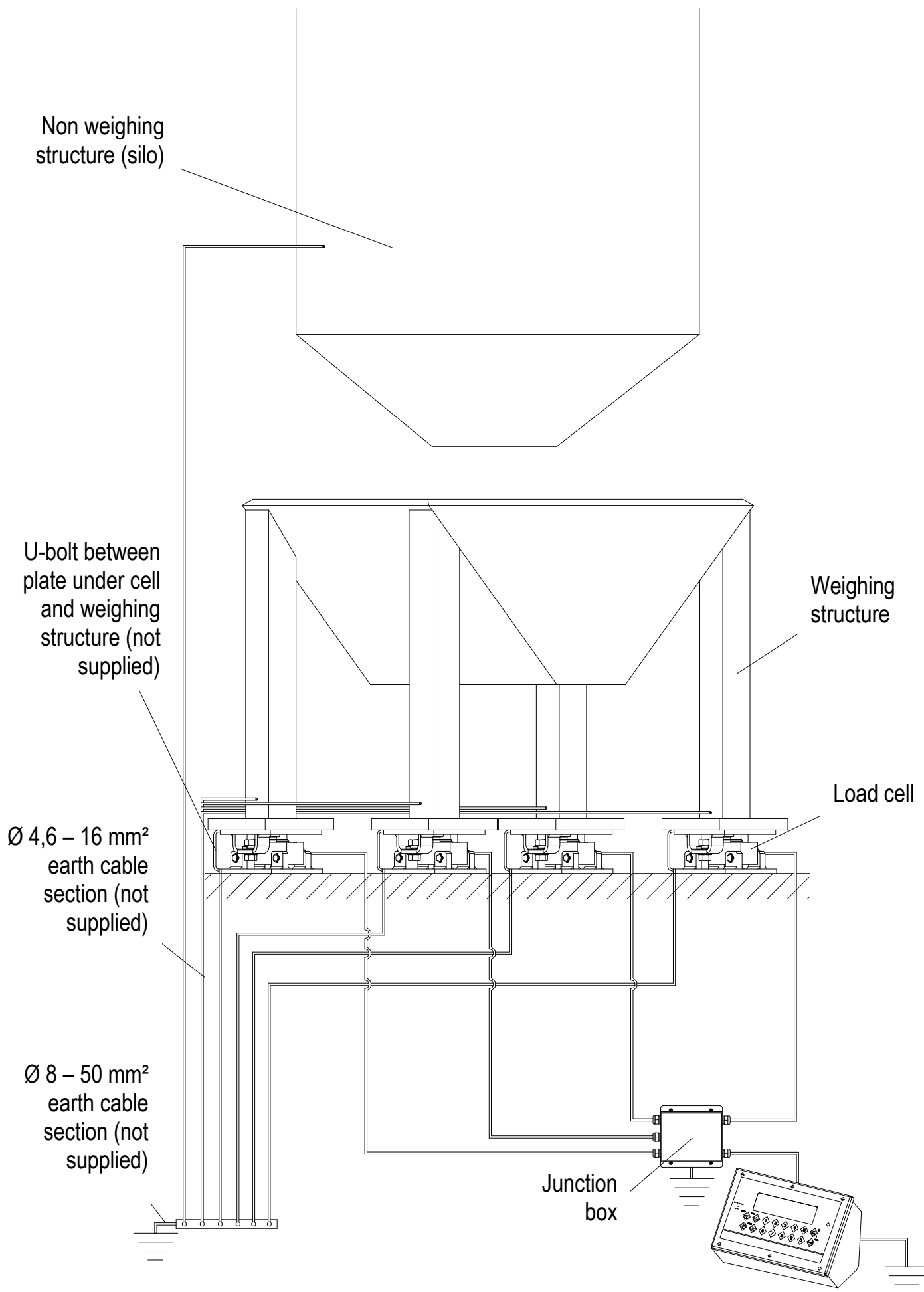



## 1.3 AXLE WEIGHING SYSTEM INSTALLATION: USEFUL INFORMATION

### RULES FOR AN OPTIMAL INSTALLATION OF THE SYSTEM:

1) The resting surface below the modules should be coplanar and well levelled; this surface should have a hardness of at least 100 kg/cm<sup>2</sup> (usual value for the reinforced concrete);

NOTE: a too high inclination can sensibly lessen the precision of the system;

2) In the axle weighing, create a well levelled area and then the weighing platforms, with a suitable length;

3) The bottom beneath the weighing area must sustain, without sinking, concentrated loads equal to at least 1,5 times the maximum capacity of the module;

4) The weighing performance can be influenced by the type of weighed vehicle and the status in which it is maintained;

5) In the axle weighing it's advisable to not weigh vehicles which transport liquids;

6) Once the system is optimised, it is advisable to maintain always the same direction.

### WHEN CREATING A LEVELLED AREA BEFORE AND AFTER THE PLATFORMS, IN THE AXLE WEIGHING APPLICATIONS

The levelled area is necessary when one needs to weigh vehicles with more than two axles. In any case, these are advised in all the axle weighing applications, in order to guarantee better performance.

### CHOICE OF THE LENGTH OF THE LEVELLING AREA

The advisable minimum length of the area depends on the vehicle type, for example for a vehicle with 5 axles the length is 3.5m before and after the platforms, in order to simultaneously maintain at the same level all the axles of the truck and of the trailer.



NOTES: The best weighing condition is obtained by creating a levelling area of a length equal to double that of the longest vehicle to be weighed.

### RULES FOR AN OPTIMAL USE OF AXLE WEIGHING IN STATIC MODE

1) The vehicle wheels must be positioned correctly within the guiding bands, avoiding to touch the area around the loading surface;

2) Once the vehicle is positioned, release the brake and turn off the motor;

3) Carry out the necessary weighing operations;

4) It is advisable to not weigh vehicles which have flat tyres.

### RULES FOR AN OPTIMAL USE OF THE AXLE WEIGHING SYSTEM IN DYNAMIC MODE

1) Transit at the lowest and most constant possible speed (5 km/h), avoiding braking while weighing;

2) It is advisable to not weigh vehicles which have flat tyres.

## 2. CONNECTION TO THE LOAD RECEIVER

### 2.1 ANALOG LOAD CELLS

**IMPORTANT: Respect the electrical precautionary measures indicated in section 1.**

After having followed the instructions regarding the platform or the load receiver, the screened cable leading from the load cell(s) must be connected to the instrument through the CELL1 terminal board and the CELL1, CELL2, CELL3, CELL4 connectors; see section 8.

The terminal board of the indicator may be connected to the 6-wire load receiver (with use of SENSE), or simply 4-wire; for this, through jumper J7 and J8 it is possible to choose whether to short-circuit the SENSE with the POWER SUPPLY (jumpers closed) or not (jumpers open).

The SENSE allows compensating for any drops in voltage in the part of the cable that connects the instrument to the transducer. It is useful when the distance between the indicator and the transducer is greater than 10 m.

The 4-pin connectors instead allow just the 4-wire connection.

To make the connection qualified personnel must open the instrument (see terminal board connections section 8).

**TAKE NOTE: if there is just one LOAD RECEIVER, it is possible to make a 6-wire connection (use of sense) directly with the terminal board, removing the J7 and J8 jumpers.**

**If there are two or more LOAD RECEIVERS, one should close the J7 and J8 jumpers (sense and power supply are short-circuited) and make the 4-wire connection.**

**Normally the indicator comes already connected to the platform and is ready to use.** If this is a LEGAL version instrument, access to the connection will be subject to a legal SEAL.

Follow the instructions for preparing the platform for use.

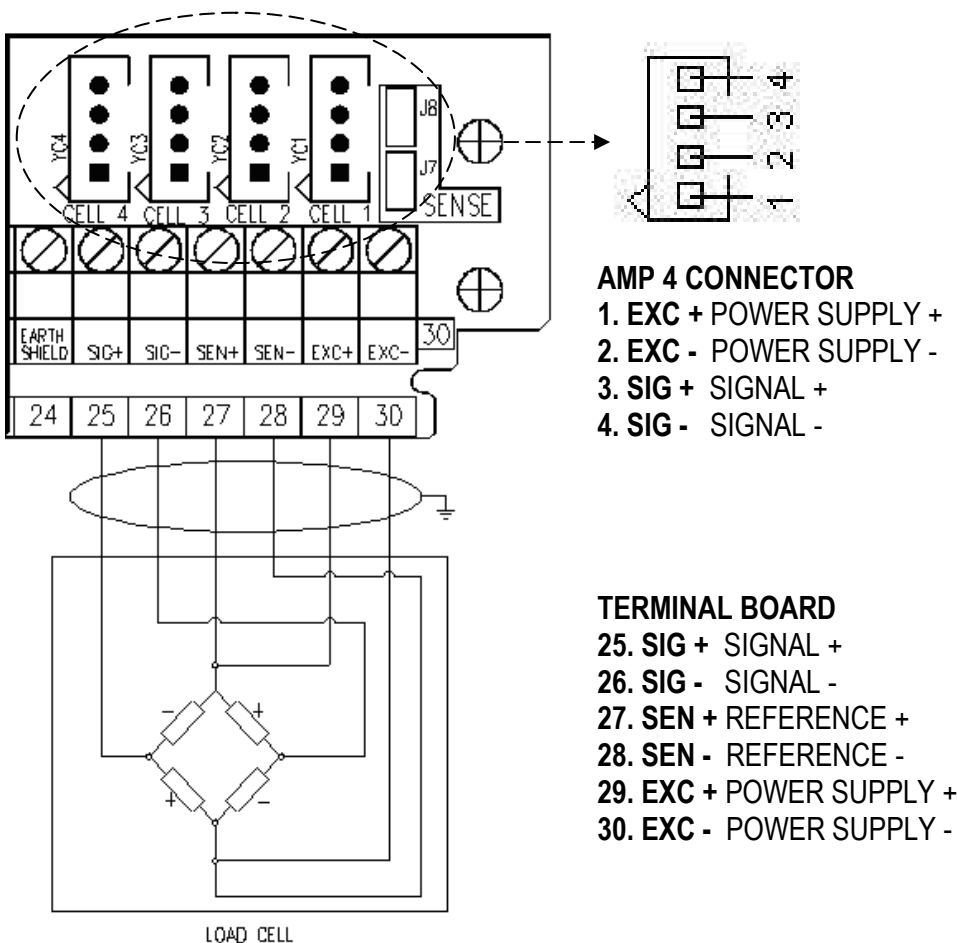

See section 8 for further information.

## 2.2 DIGITAL LOAD CELLS

### IMPORTANT:

- **Respect the electrical precautionary measures indicated in section 1.**
- **Read carefully and apply what is described in chapter 5.3**

After having followed the instructions regarding the platform or the load receivers, the screened cable leading from the load cell(s) must be connected to the instrument through the COM3 RS485 terminal board.

**Below is the RS485 connection for digital load cells in the CoM3 of the indicator (with X15 integrated circuit):**

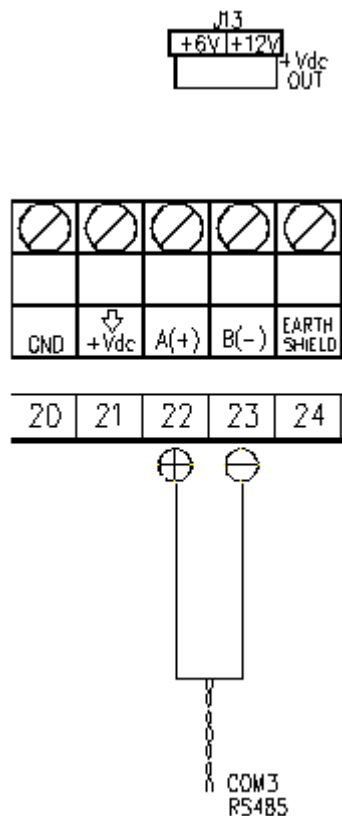

TERMINAL	MEANING
20. GND	POWER SUPPLY -
21. +Vdc	POWER SUPPLY +
22. TX+/RX+	Line 485 A(+)
23. TX-/RX-	Line 485 B(-)

The voltage value of terminal 21 can be selected through J13 jumper, according to the required load cells power supply.

The possible selections are 6V or 12V, working if the relative power supply is connected to the indicator (respectively battery or external power supply, see J13 jumper description in section 8.1).

Consequently, the functioning with only the battery doesn't allow the connection of those digital load cells that require 12V power supply.

In the case of digital load cells connected to a digital junction board, connect the COM3 RS 485 terminal board of the indicator to the RS485 port of the junction board, by following the relative manual and the section 5.1.

In the case of ring connection of more digital junction boards or DGX, connect the COM3 RS 485 terminal board of the indicator to the RS485 port of the first junction board/DGX, by following the relative manual and the section 5.1.

### 2.2.1 CONNECTION OF LOAD CELLS TO INDICATOR

The load cell has a digital output with an RS-485 interface (4-wire). In regards to the power supply, it needs an external continuous voltage (CC).

To configure the cells it is necessary to go to the **nuM.SCA >> 1 SCALE >> CELtyP** step and then choose the type of cell:

- AnALoG**      Cells type analog
- dGX**        Cells type digital DGX
- rCd**        Cells type digital RCD
- CCi Ad**     Cells type digital CCI AD
- rC3d**       Cells type digital RC3D
- C16i**       Cells type digital C16i
- WWS**       Cells type digital WWS
- (!)AnALoG**

In most cases in order to avoid to make a jumper connection between the cells one uses a junction box which is connected to the indicator on the terminals dedicated to the 485 port. In between the terminals one needs to apply 2 Pull Up resistances and a termination one in order to have a minimum 0,2 V voltage between A(+) and B(-) (terminals 22 and 23):

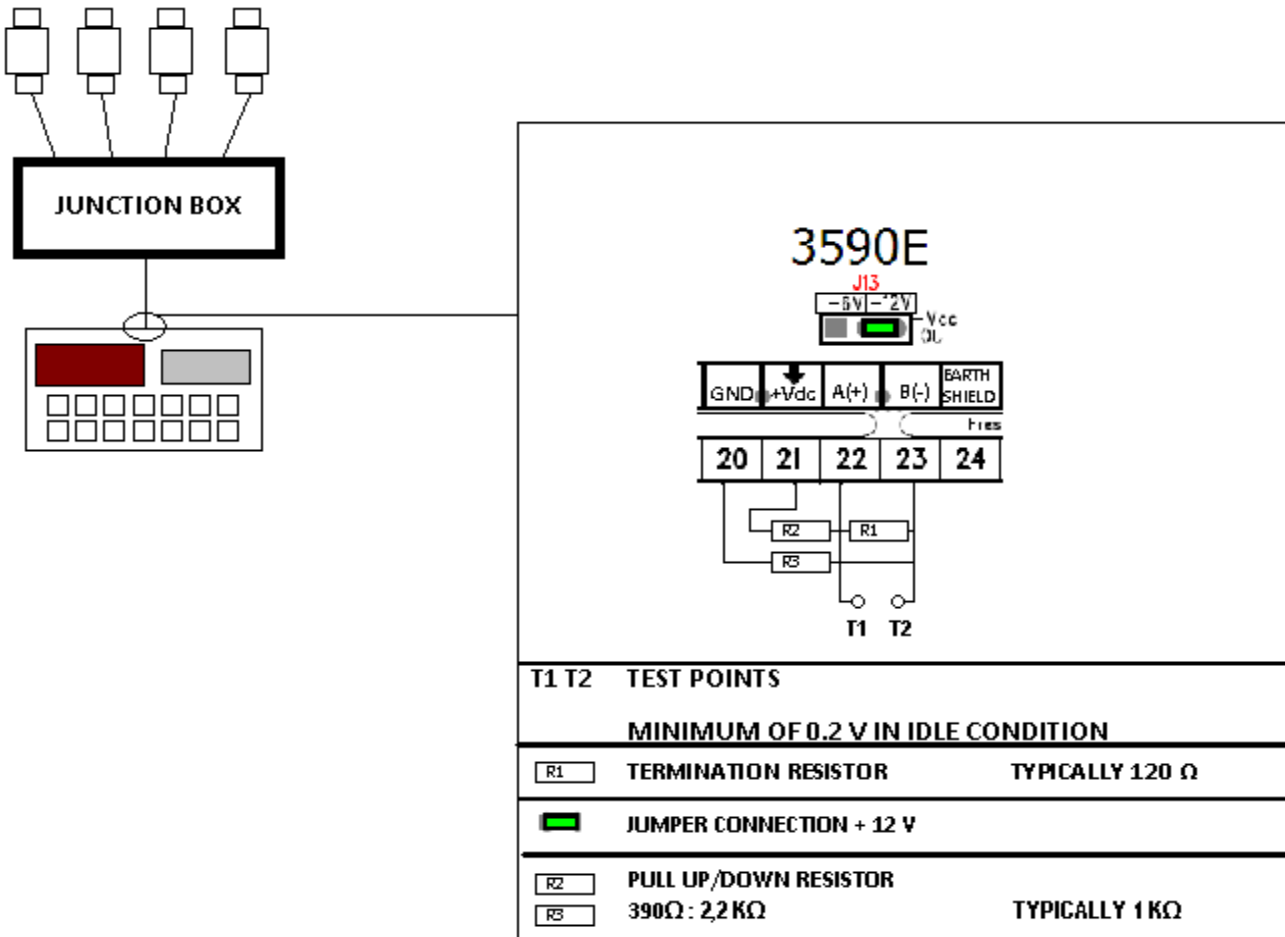

Since each cell uses a filter different than the default one, the functioning speed varies from one load cell type to another. For the length and section of the connection cables, see the section **“MAXIMUM LENGTHS ALLOWED FOR THE CABLES”**

### 2.3.2 C16i DIGITAL CELL CONNECTION

In order to connect the C16i load cells to the indicator, a SC232/422B converter is necessary so that it is possible to connect directly on the terminal board in 232 on the pins 14 15 and 16. To do this one should enter in the step **SEtuP >> SEriAL >> PortS** and set the ports in this way:

Parameter	COM 1	COM 2	COM 3
AX.Pr.PC	ComAux	ComPrn	ComPC

The connection of the cells to the converter are to be made through the junction box or in parallel as described in the following scheme:

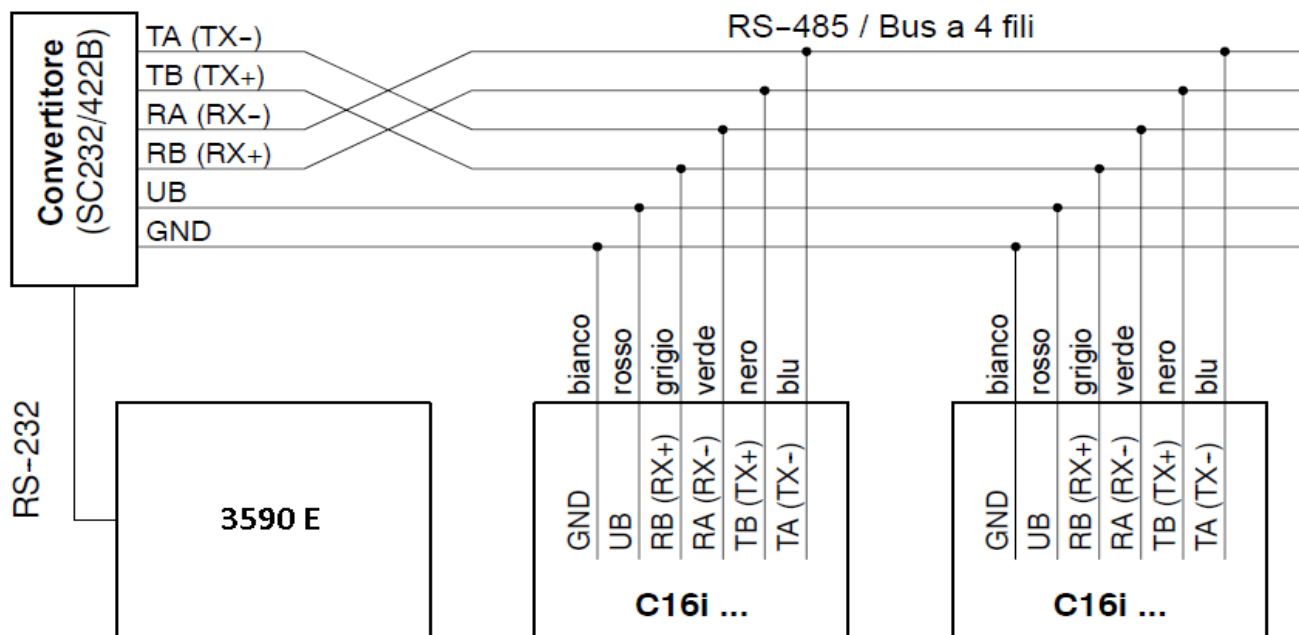

For these cells it is necessary to programme a few parameters of the configuration programme of the C16i cell, which may be accessed by connecting the converter to the PC.

By entering in **Parameters >> Basic settings** one sets the type of filter one wants to use and the check sum is enabled:

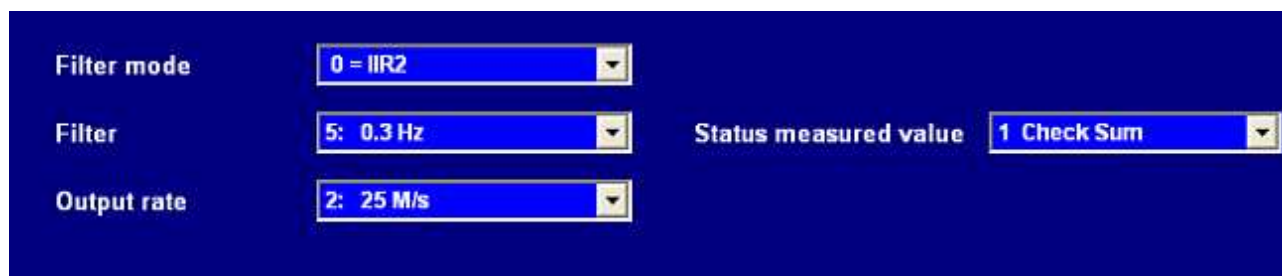

By entering in **Parameters >> Communication** it is necessary to insert the COF format and the ASCII delimitation as shown in figure:

The screenshot shows a menu titled "Output format values [ MSV? / MAV? / FRS? ]". It contains two main settings:

- Output format COF:** The value is set to **8**. A grey box next to it contains the text "binary: 4 byte, MSB ... LSB (=CRC)" and "Mode: standard".
- Delimiter for ASCII:** The value is set to **172**.

Once the type of cell is chosen (**SEE 2.3**) one needs to enter the number of cells used, and the indicator shows: **Cells Number**.

After having chosen the number of cells the indicator automatically enters in the step

**SEt.485** Set 485 Address cells

Enter the number of the cell and the relative serial number one after the other and at the end press C. The following appears:

**Snd.CFG** Send configuration?

Press Enter and the setting from the indicator is finished.

### 2.3.3 RCD DIGITAL CELL CONNECTION

Once the type of RCD cell has been chosen, one should enter the number of cells used, the indicator shows: **Cells Number**.

After having chosen the number of cells, the indicator automatically enters in the step

**SEt.485** Set 485 Address cells

Enter the cell number and the relative serial number one after the other, and at the end, press C. The following appears:

**Snd.CFG** Send configuration?

Press Enter and the setting from the indicator is finished.

For the connection of the RCD cells to the indicator, a junction box is necessary, which is connected to the indicator through 485. (**SEE SECTION "RS 485 CONNECTION"**)

<b>Part reserved for the Authorised Technical Personnel</b>
---

### 3. SETUP ENVIRONMENT

By "SETUP environment" we mean a certain menu inside which all the indicator operating parameters can be set.  
**To enter it, turn on the instrument and, while the firmware version is displayed, press the TARE key for an instant.**

The indicator shows:

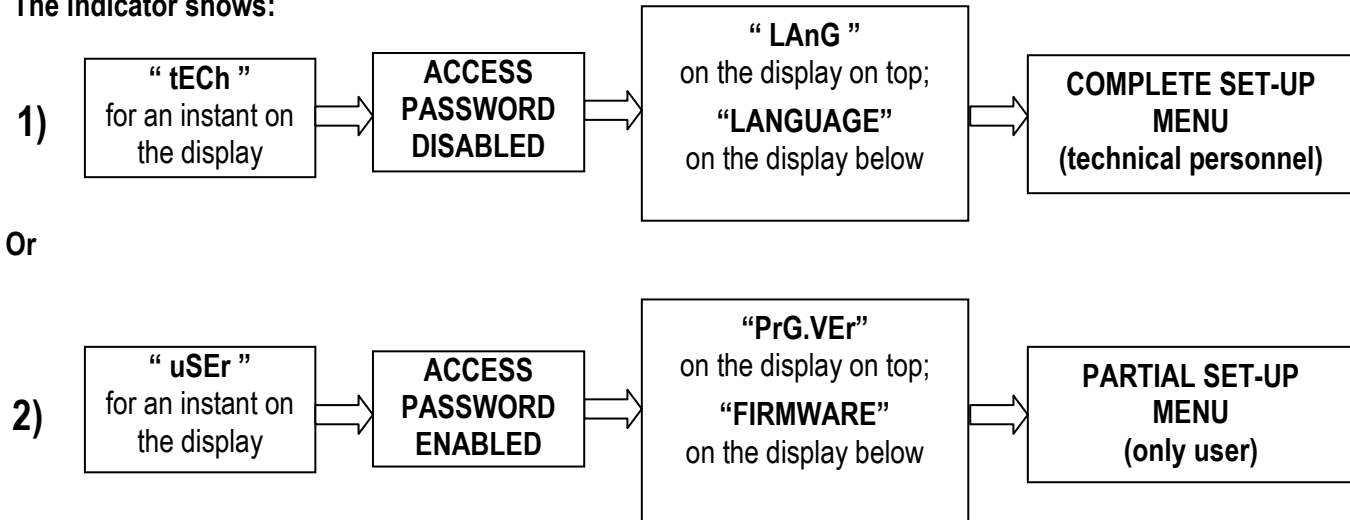

If you are in choice 2) and you want to access the complete set-up menu one should:

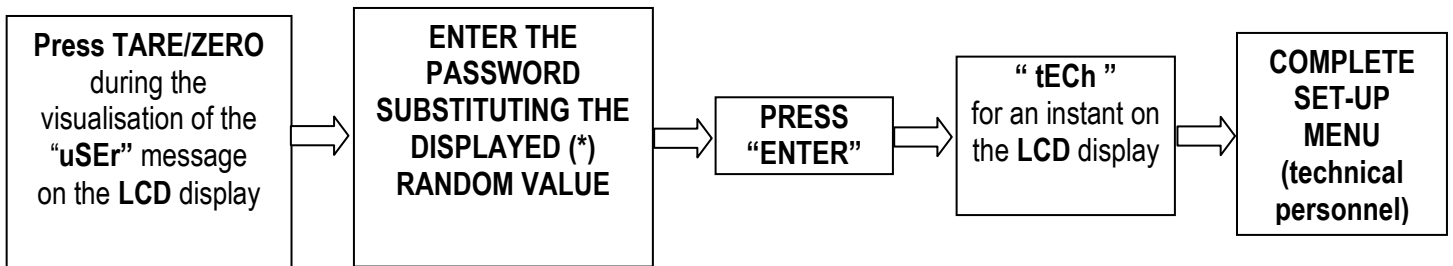

(\*) If one has forgotten the password, one should communicate the displayed number to the manufacturer, who will supply a valid password JUST FOR THAT SPECIFIC NUMBER.

In the parameter description and in the block diagram:

- The **METRIC** parameters are shown with the (\*) symbol, and, with approved instrument, these may not be visible or read only. See the explanation of the parameter for the details.  
**NOTE: The indicator is approved when the J1 jumper of the motherboard is closed (see the electrical scheme in the final chapter).**
- The **CONDITIONAL STEPS** are shown with the (§) symbol, and are not accessible or displayed in specific conditions, shown in the step description.
- The **DEFAULT VALUES** are shown with the (!) symbol placed next to the step and at the end of it.

**FUNCTION OF THE KEYS IN THE SET-UP ENVIRONMENT**

<b>KEY</b>	<b>FUNCTION</b>
<b>F6, F7</b>	Allow to scroll forwards and backwards in the menu steps or in the parameters inside a step.
<b>Fn / ENTER</b>	Allows to enter a step or confirm a parameter inside a step.
<b>C / DEL</b>	Allows to exit a step without confirming any changes made and to go to the previous level. While entering a code, it quickly zeros the displayed value.
<b>F5</b>	It allows to print the entire configuration of the set-up environment (if one is in the main menu), or to print the configuration of the single step (if one is in the desired step). The display shows the "PRINT" message: press <b>ENTER</b> to confirm or <b>C</b> to cancel.
<b>NUMERIC KEYBOARD</b>	Allows entering digits or characters.

The display show the current parameter and its description; generally, when one exits a step the instrument places itself on the following step.

**TO EXIT THE SET-UP ENVIRONMENT, PRESS THE C KEY MANY TIMES UNTIL THE INDICATOR SHOWS:**

**EXITING SETUP:  
SAVE ?**

**CONFIRM WITH ENTER TO SAVE CHANGES MADE OR PRESS ANOTHER KEY TO NOT SAVE.**



### 3.1 SET-UP ENVIRONMENT BLOCK DIAGRAM

The following diagram represents the structure of the indicator's set-up environment; each step has been described in detail in the paragraph 3.2.

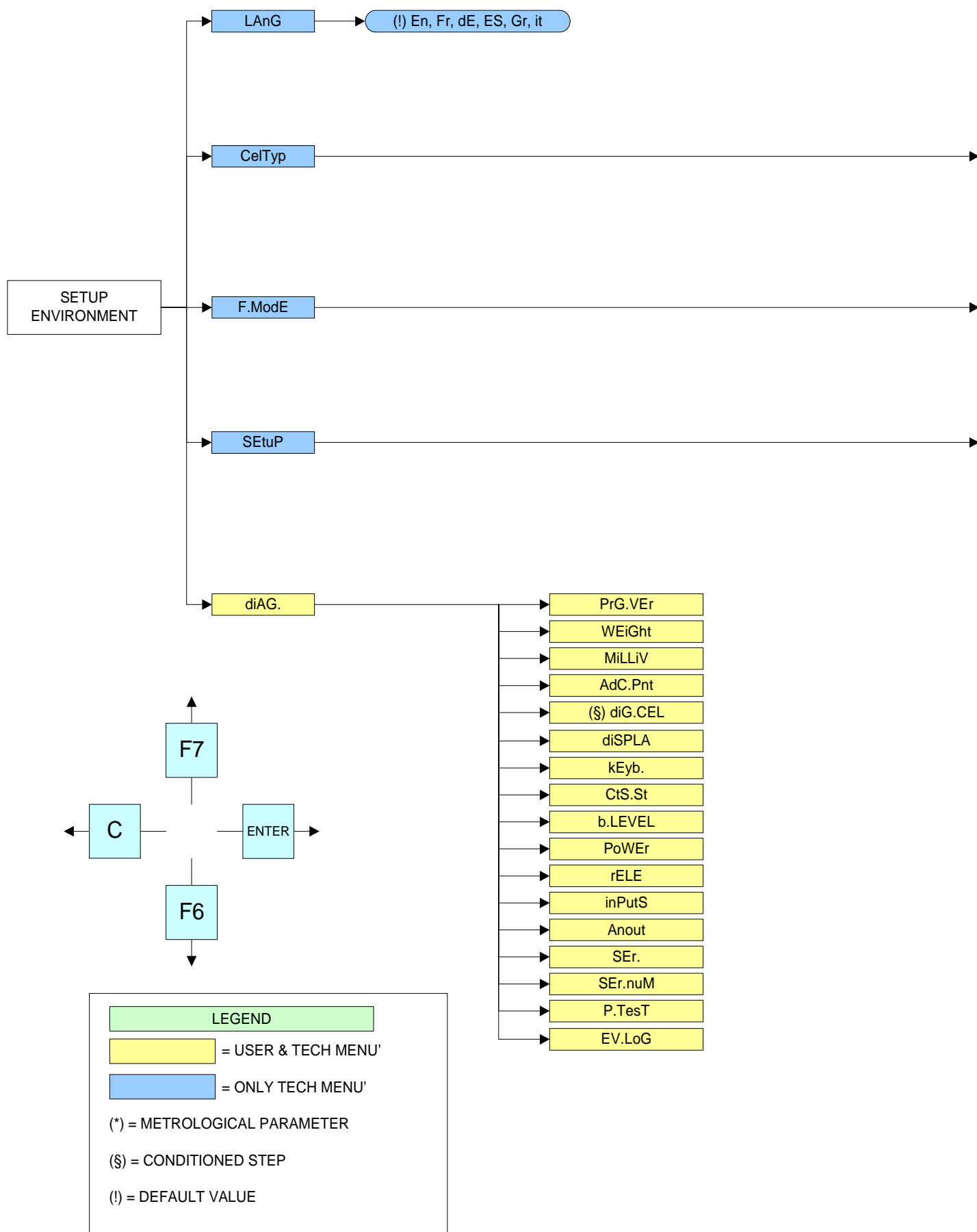

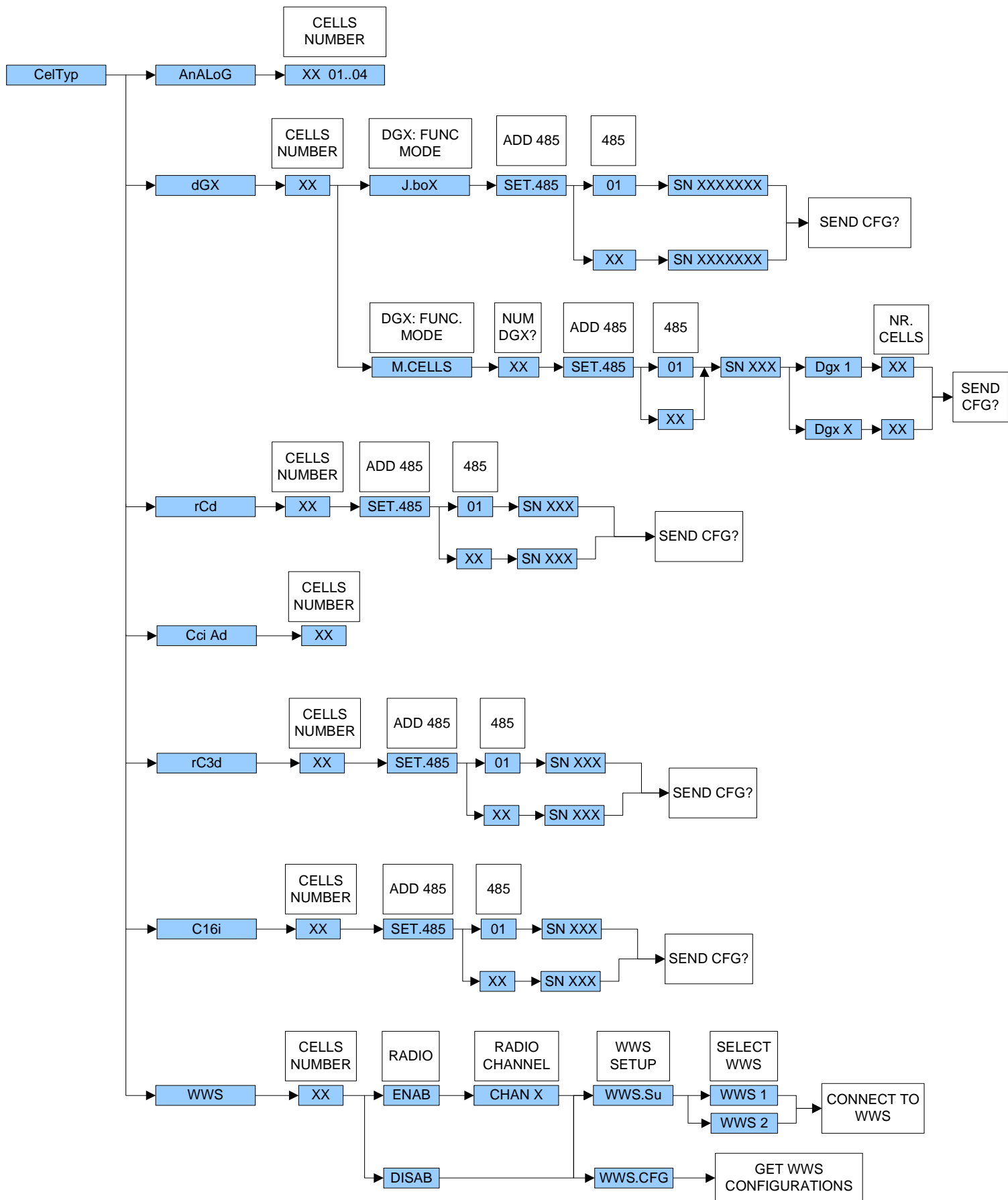

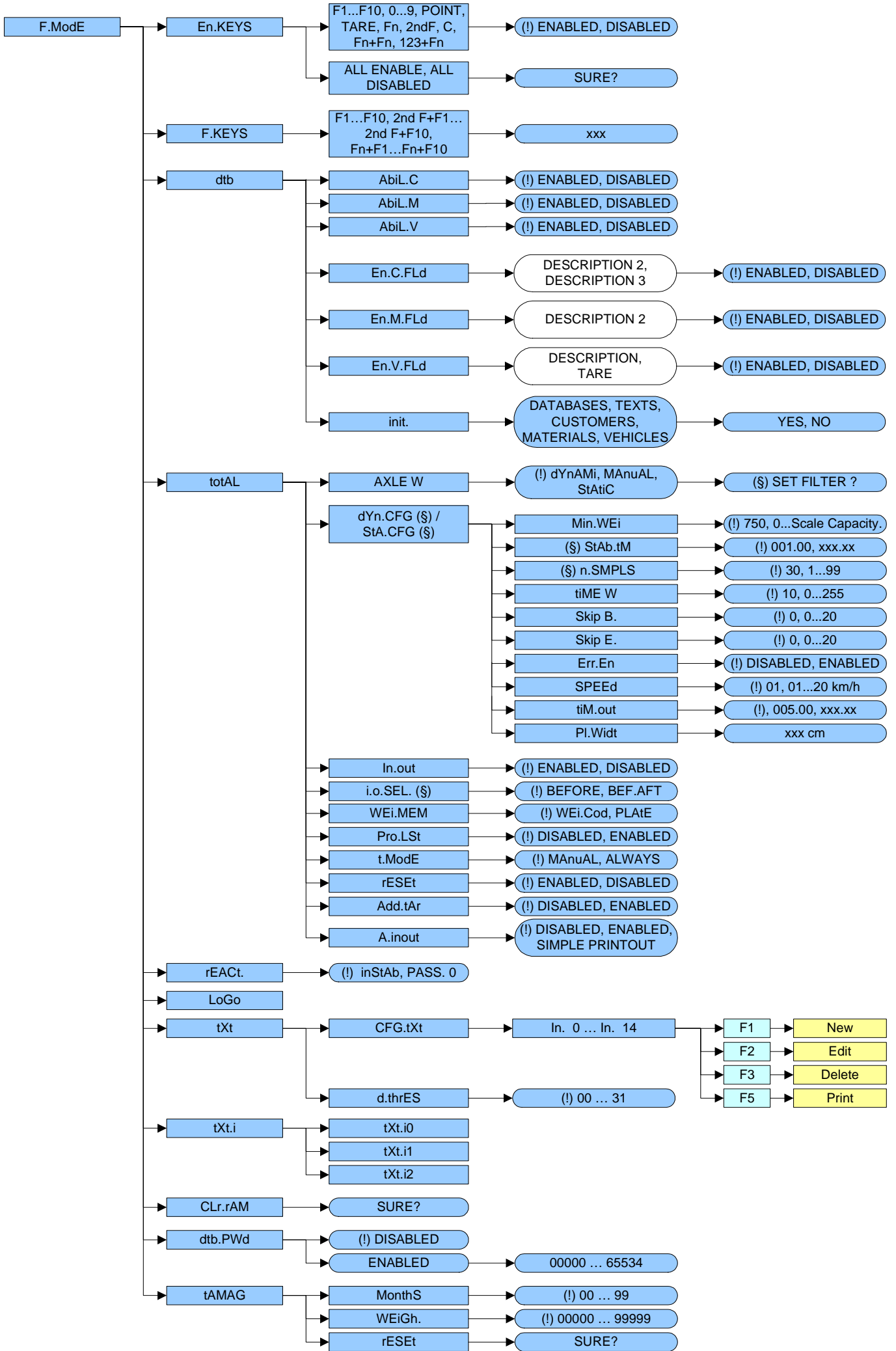

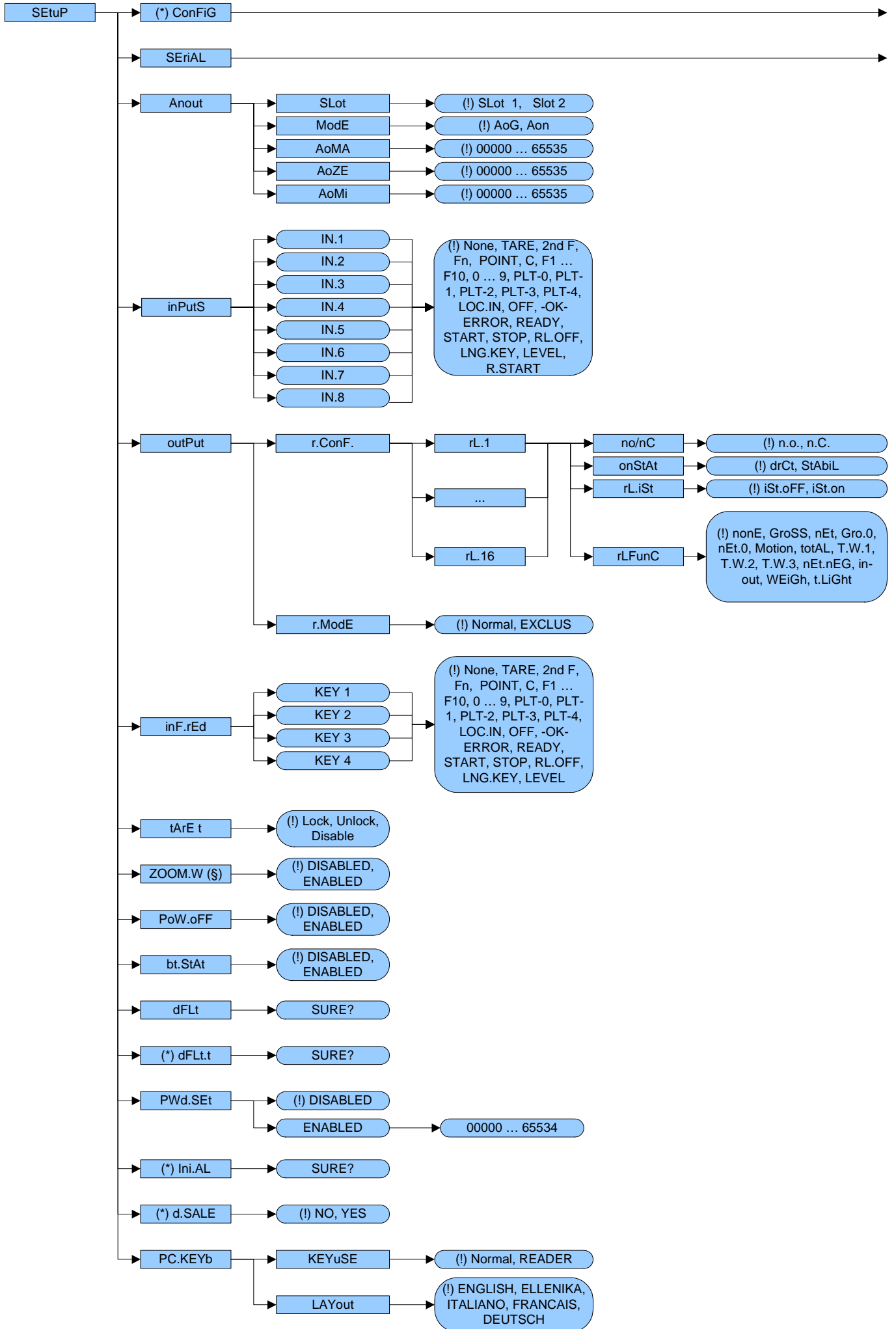

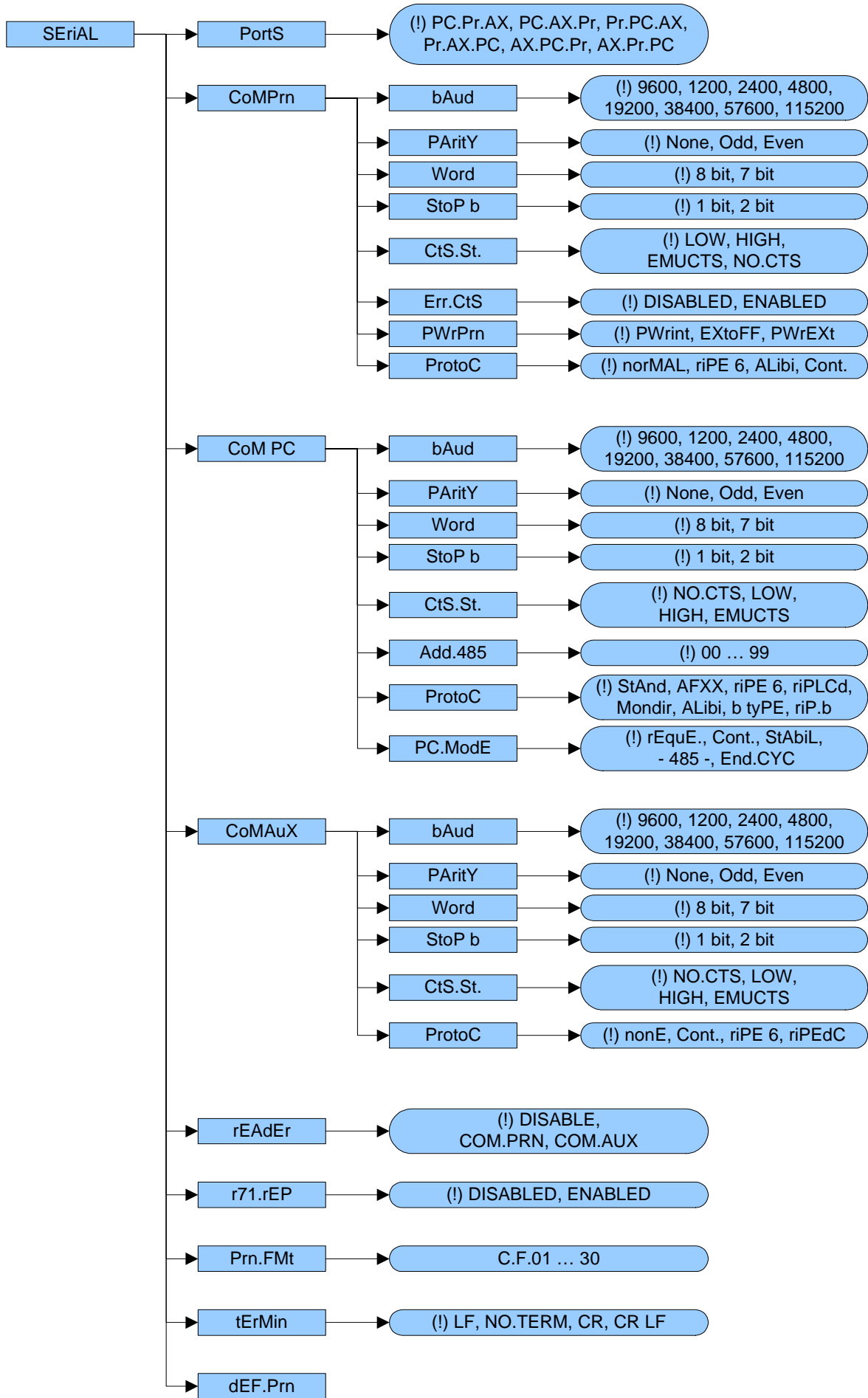

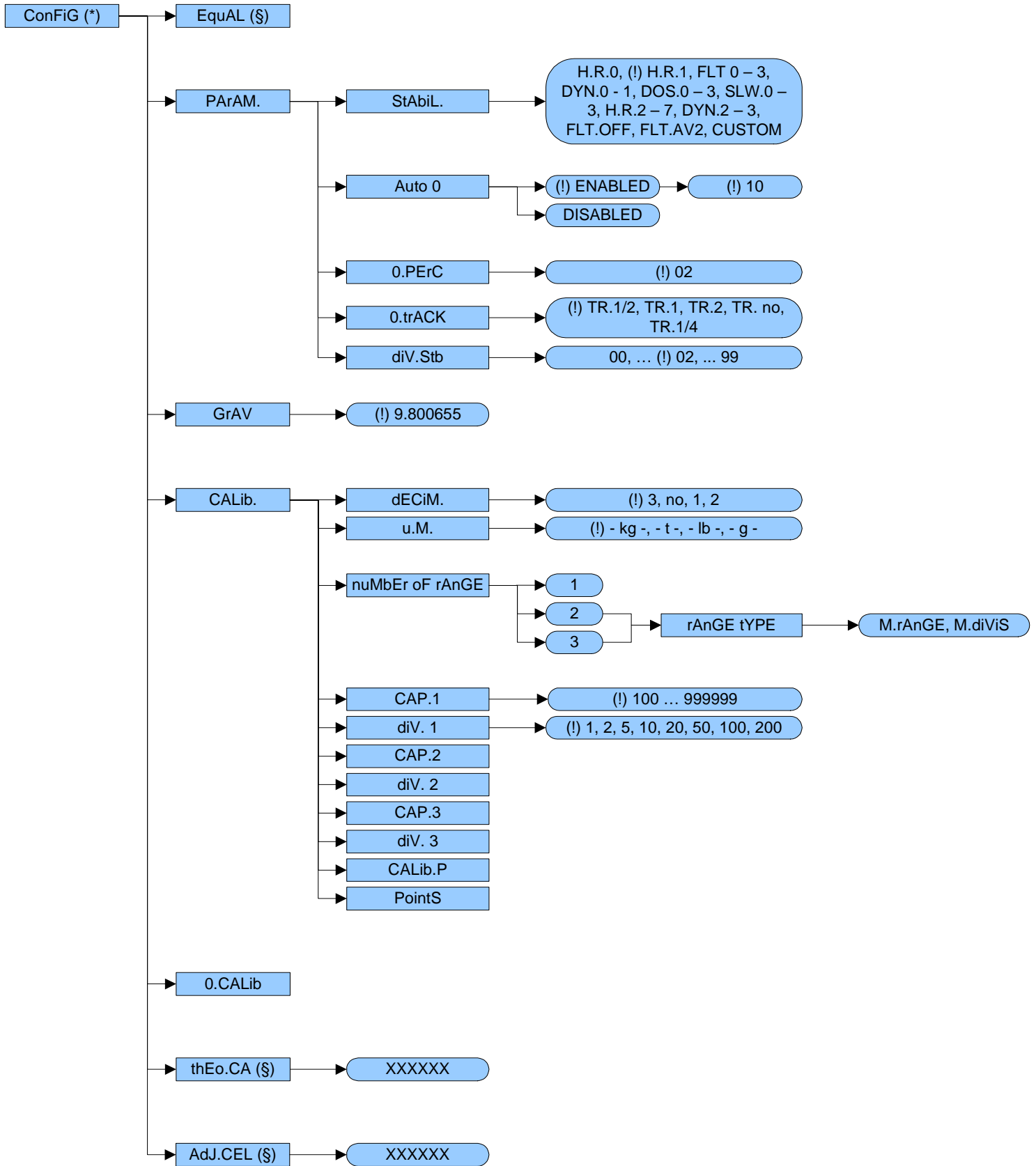

## 3.2 DESCRIPTION OF THE STEPS

### << LAnG >> FIRMWARE LANGUAGE

<u>Parameter</u>	<u>Language</u>	<u>Used Codepage (see section 7.2)</u>
- En	English	1252 Windows Latin 1
- Fr	Français	1252 Windows Latin 1
- dE	Deutsch	1252 Windows Latin 1
- ES	Español	1252 Windows Latin 1
- Gr	Ellenika	1253 Windows Greek
- It	Italiano	1252 Windows Latin 1

(!) En

### << CELtyP >> CELL TYPE

This menu allows setting the type of cells used (analogue or digital):

- in case of analogue cells it will be possible to enter the number of analogue channels. Follow the instructions in section 3.3.1.
- in case of digital cells / DGX conversion card, it will be possible to enter the number of cells forming the scale and follow the instructions in section 3.3.6. Only load cells of the same model and the same capacity can compose two digital platforms.

**NOTE: The instrument is able to manage up to 4 analogue channels or 16 digital cells / 16 analogue load cells converted as digital through DGX conversion cards.**

(!) AnALoG

### << DGX.MOD >> DGX FUNCTION MODE

- M.CELLS: Conversion into digital of each single analogue load cell.
- J.boX: for use of the manufacturer.

Follow the instructions in section 3.3.6.

(!) J.boX

### << DGX.NUM >> NUMBER OF DGX CARDS

This menu allows setting the number of DGX composing ALL THE SCALES.

Follow the instructions in section 3.3.6.

### << CEL.Add >> SET 485 CELLS ADDRESS

See section 3.3.7.

**<< F.ModE >> SCALE FUNCTIONING****<< En.kEyS >> KEYS ENABLING**

It is possible to enable/disable each single key of the keyboard:

- select the desired key with **F6/F7**:

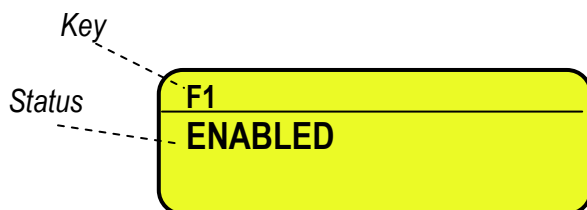

- press **ENTER** to modify the setting:

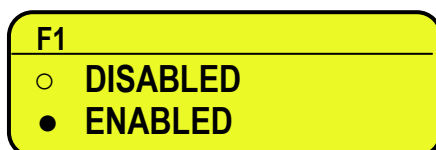

- Press **F6/F7** to select “ENABLED” or “DISABLED” and **ENTER** to confirm.

**QUICK FUNCTION RECALL THROUGH 999 + 123 + Fn**

If the function 123 + Fn is not enabled, is possible directly recall the desired function with the keys combination 999 + 123 + Fn in weighing phase.

**NOTES:**

- It's possible to enable/disable all the keys together, by selecting “ENABLE ALL” or “DISABLE ALL” (the confirmation will be requested with the message “SURE?”).
- The disabling of the keys will have effect only the WEIGHING PHASE, in other words, not inside the menus, databases, etc...
- The turning off of the instrument (long pressing of the **C** key) will always be enabled.
- The disabling of the keys will be applied also on the PC keyboard, if connected.

**(!) ENABLE ALL**



## << F.keys >> FUNCTION KEYS COUPLING

It's possible to modify the function of the F1, F2.....F10 keys, and the combination of these with the **2nd F** or **Fn** keys (i.e. "2nd F + F1", "Fn + F2", etc...).

Through **THE FUNCTION LIST**, it is possible to link to a key up to 10 functions, which are executed one after the other.

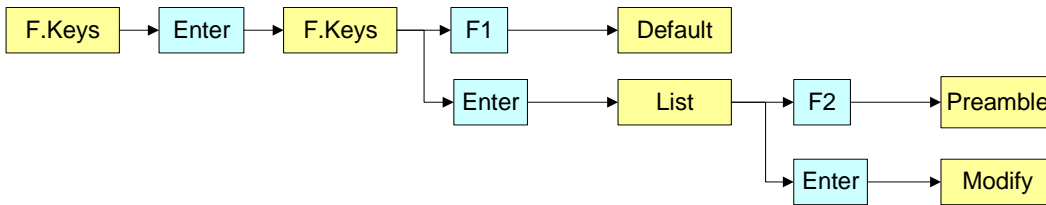

- select the desired key with F6/F7:

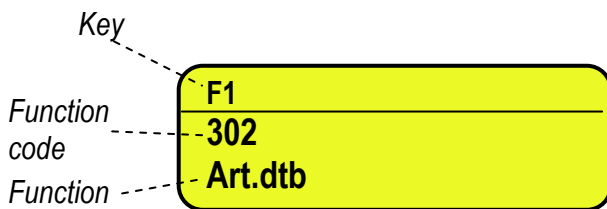

- press **ENTER** to see the list:

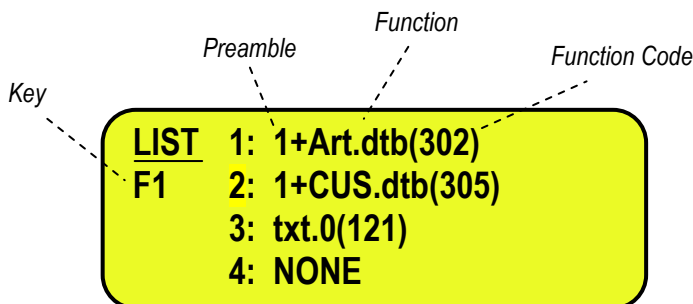

- press **ENTER** to modify the setting:

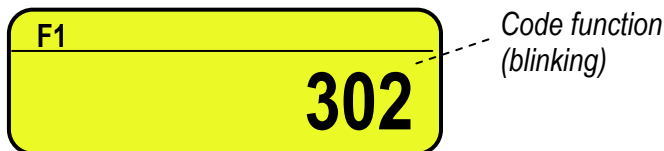

### Quick introduction of the maximum and minimum thresholds

It is necessary to associate the function 500 and 501, used for the settings of the totalisation thresholds, each to a function key between **F1** and **F10**. If one digits a value and then presses one of the programmed keys, the minimum or maximum threshold is set.

**Preamble function**

It is possible to associate also a preamble (numeric value) to the F1, F2...F10 keys. In this way, when the key is pressed, the preamble is automatically used as parameter of the function to be executed.

The functions to which can be associated a preamble are:

FUNCTIONS	PREAMBLE VALUE
Input text configuration (tXt)	Number of the input text that one wants to modify.
Coupling print formats (Prn.Fmt)	Number of the format on which one wants to modify the coupling.
Setpoint configuration (SETPNT)	Number of the setpoint that one wants to modify.
Article database (Art.dtb)	Number of the article that is automatically selected

By pressing a key with the function of an associated database (for example articles database) and the preamble is enabled to the value 9999, it is required disable the eventually enabled record.

**EXAMPLE:**

9999 + F1(article database), deselect active article.

- press **F2** to insert the preamble:

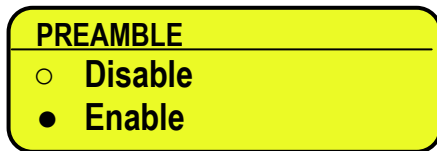

- select enable and confirm with **ENTER**

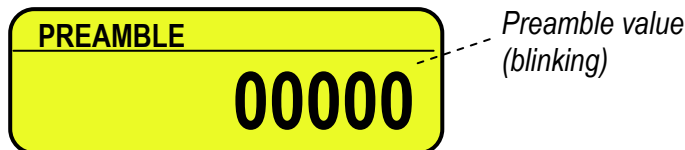

- insert the desired value through the numeric keyboard and confirm with **ENTER** (by confirming the value 0, the preamble is disabled).
- If one sets the value 9999 as preamble of a key matched to a database function, by pressing the key the active record is deselected

*Key (preamble + function)*

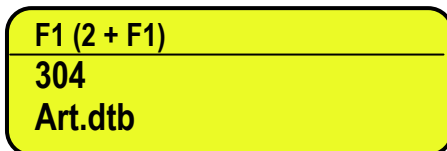
**KEYS' FUNCTIONS IN THIS STEP**

- ▲ scrolls backward inside the list of the keys.
- ▼ scrolls forward inside the list of the keys.
- F1** performs the default of the function pairing of the keys.
- F2** inserts the preamble.
- ENTER** modifies the code of the function in the current key; while entering it confirms the entered code.

**NOTE:** by pressing the **. /HELP** key, it's possible to display the list of the keys used inside this step and their functions. The list is automatically shown. If one wants to scroll the list of the keys in manual mode, it is possible to use the arrow keys (F6 ▼ and F7 ▲).

<b>CODE</b>	<b>BASIC FUNCTION</b>	<b>DEFAULT KEY/S</b>
100	Scale Zero (ZERO)	ZERO
102	Tare Execution (TARE)	TARE
103	Activate printer (PRN-ON)	Fn + 0
104	Simple printout (PRINT)	F5
105	Repetition of the last executed printout (CPY.PRN)	2ndF + F5
106	Change weight visualization (WEI.VIS)	2ndF + F8
107	Change visualization LCD display (LCD.VIS)	2ndF + F9
108	Lock/Unlock the keyboard (L. KEYB)	F1 pressed at length
109	Display of Net Weight with sensitivity x 10 (Disp.10)	F2 pressed at length
110	Setting Date/Time (CLOCK)	F3 pressed at length
111	Diagnostic Menu (Diag.)	F4 pressed at length
112	Lock/Unlock Tare (L. TARE)	F5 pressed at length
113	Input Texts Configuration (txt)	F4
114	Calculator (CALC)	
115	Printout and Reset Partial Total (Prn.0.t0)	F8
116	Printout and Reset General Total (Prn.0.t1)	
117	Printout and Reset Grand Total (Prn.0.t2)	
118	Diagnostic peripheral units (P.DIAG)	
119	Com data diagnostic (COM.DAT)	
120	Customized display enabling or change of visualization if already enabled (CST.DSP)	Fn + F9
121	Input text 0 configuration (txt.0)	
122	Input text 1 configuration (txt.1)	
123	Input text 2 configuration (txt.2)	
124	Input text 3 configuration (txt.3)	
125	Input text 4 configuration (txt.4)	
126	Input text 5 configuration (txt.5)	
127	Input text 6 configuration (txt.6)	
128	Input text 7 configuration (txt.7)	
129	Input text 8 configuration (txt.8)	
130	Input text 9 configuration (txt.9)	
131	Input text cancellation: from 0 to 14, 99 erase all the texts (txt.rSt)	
132	Print format sending: from 0 to 30 (Send.P.F)	
<b>OTHER FUNCTIONS</b>		
200	Format Linking to the Printout Functions (Prn.Fmt)	
201	Format Linking to the Partial Total Printout(SND.FMT)	
202	Setpoint configuration (SETPNT)	

<b>SPECIAL FUNCTIONS</b>		
300	Simple axle Weigh/Input Axle Weigh (IN.WEI.)	F6
301	Output Axle Weigh (OUT.WEI.)	F7
302	Customer database (DB.CUS.)	F1
303	Material database (DB.MAT.)	F2
304	Vehicle database (DB.VEH.)	F3
305	Deselect active records (UNS.ALL.)	2ndF + F4
306	Deselect customer (UNS.CUS.)	
307	Deselect material (UNS.MAT.)	
308	Deselect vehicle (UNS.VEH.)	
310	Format Linking to the Input Axle Weigh Printout(FM.IN)	
311	Format Linking to the Output Axle Weigh Printout(FM.OUT)	
312	Format Linking to the Axle Weigh with Tare Printout (FM.SING)	
313	Customer selection with alphabetical research (ALP.CUS)	
314	Material selection with alphabetical research (ALP.MAT)	
315	Vehicle selection with alphabetical research (ALP.VEH)	
317	Network state (nEt.StA)	
318	Network monitor (nEt.Mon)	
319	Archives alignment (db.ALiG)	
320	Unlock weighing list records (unLoCK)	
321	Connect network (n.StArt)	
322	Disconnect network (n.StoP)	
323	Send remote key (rEM.KEY)	
324	Send remote long key (r.KEY.L)	
325	Remote scale change (rEM.CGh)	

<b>VISUALISATION / PRINTOUT MENU</b>		
400	Number of Ticket Copies (CoPiES)	
401	Set progressive digits (Prg.1)	
402	Set progressive ticket (Prg.2)	
403	Automatic Lot Resetting (0.Prg)	
404	Display Customer Total (V.t.Cus)	
405	Print Customer Total (Prn.Cus)	
406	Reset Customer Total (0.Cus)	
407	Reset all Customer Totals (0.CusS)	
408	Display Material Total (V.t.Mat)	
409	Print Material Total (Prn.Mat)	
410	Reset Material Total (0.Mat)	
411	Reset all Material Totals (0.MatS)	
412	Display Vehicle Total (V.t.VEH)	
413	Print Vehicle Total (Prn.VEH)	
414	Reset Vehicle Total (0.VEH)	
415	Reset all Vehicle Totals (0.VEHs)	
416	Display Partial Total (V.t-0)	
417	Print Partial Total (Prn.t-0)	
418	Reset Partial Total (0.t-0)	
419	Display General Total (V.t-1)	
420	Print General Total (Prn.t-1)	
421	Reset General Total (0.t-1)	
422	Display Grand Total (V.t-2)	
423	Print Grand Total (Prn.t-2)	
424	Reset Grand Total (0.t-2)	
425	Reset Scale Totals (0.t-ALL)	
426	Reset Weights List (0.W.LIST)	
427	Alibi Memory Reading (ALIBI)	
428	Printout and Reset Customer Total (Prn.0.CuS)	2ndF + F1
429	Printout and Reset Material Total (Pr.0.Mat)	2ndF + F2
430	Printout and Reset Vehicle Total (Pr.0.VEH)	2ndF + F2
431	Progressive edit (Pr.Edit)	

<b>WEIGHING THRESHOLDS</b>		
500	Set maximum threshold (tr.HI)	
501	Set minimum threshold (tr.LO)	
<b>DYNAMIC WEIGHING FUNCTION</b>		
600	Close dynamic cycle (CLO.CYC)	F9
601	Reset dynamic cycle (RES.CYC)	F10
602	Reset error dynamic cycle (RES.CYC)	
603	Beginning axles to skip (SKIP.B)	
604	Ending axles to skip (SKIP.E)	
605	Axle capture Configuration (AXL.CFG)	
606	Setup WWS Platforms (WWS.Su)	
607	Axle Pause (PAUSE)	

<< dtb >> DATABASES<< AbiL.C >> ENABLING CUSTOMER DATABASE

It's possible to enable or disable the CUSTOMER DATABASE:

**ENABLED**

**DISABLED**

- Press **F6/F7** to select "ENABLED" or "DISABLED", and **ENTER** to confirm.

- Proceed up to the last suggested field, after which it automatically exits the step.

**(!) ENABLED**

<< AbiL.M >> ENABLING MATERIAL DATABASE

It's possible to enable or disable the MATERIAL DATABASE (like the **AbiL.C** step):

**ENABLED**

**DISABLED**

**(!) ENABLED**

<< AbiL.V >> ENABLING VEHICLE DATABASE

It's possible to enable or disable the VEHICLE DATABASE (like the **AbiL.C** step):

**ENABLED**

**DISABLED**

**(!) ENABLED**

<< En.C.FLd >> CUSTOMER FIELDS ENABLING

It's possible to enable one by one the fields required for the CUSTOMER DATABASE.

*Name of field*

*Status*

<b>DESCRIPTION2</b>
<input type="radio"/> <b>DISABLED</b>
<input checked="" type="radio"/> <b>ENABLED</b>

- Press **F6/F7** to select "ENABLED" or "DISABLED", and **ENTER** to confirm.

- Proceed up to the last suggested field, after which it automatically exits the step.

**(!) ENABLED**

**NOTE: The first customer description is always enabled.**

<< En.M.FLd >> MATERIAL FIELDS ENABLING

It's possible to enable one by one the fields required for the MATERIAL DATABASE (like the **En.C.FLd** step).

**(!) ENABLED**

<< En.V.FLd >> VEHICLE FIELDS ENABLING

It's possible to enable one by one the fields required for the VEHICLE DATABASE (like the **En.C.FLd** step).

**(!) ENABLED**

<< init. >> INITIALIZE DATABASES and INPUT TEXTS

By pressing **ENTER** one initialises the DATABASES (with the total values) and the INPUT TEXTS: in this way all their contents will be cancelled.

The cancellation is not immediate; the indicator requests a further confirmation (the LCD display shows "RESET DATABASES ? ENTER=YES C=NO").

By pressing **ENTER** one confirms the operation, by pressing **C**, the indicator gives the possibility to cancel all the databases **individually** in this order: INPUT TEXTS, CUSTOMER DATABASE, MATERIAL DATABASE, VEHICLE DATABASE.

<< totAL >> TYPE OF TOTALIZER (see paragraph 3.3)<< rEAct. >> REACTIVATIONS

It is possible to set whether to reactivate the printout and the input/output weigh through:

- PASSAGE BY ZERO OF THE NET WEIGHT (**PASS. 0**)

- WEIGHT INSTABILITY (**inStAb**)

(!) **inStAb**

<< LoGo >> TEXT UPON START-UP

At the start-up of the indicator, the LCD display shows a message of 2 lines of 16 characters, which is set in this step, or a 160x32 pixel photo uploadable from Dinitools™ (“\*.bmp” monochromatic format is accepted).

(!)  **DINI ARGO**

<< tXt >> INPUT TEXTS<< CFG.tXt >> INPUT TEXT CONFIGURATION

Through this step one can enter, modify or cancel the heading of the input texts which will be filled in during the weighing through the **F4** key of the indicator; refer to the user manual for further specifications. (**USER MAN.REF.**).

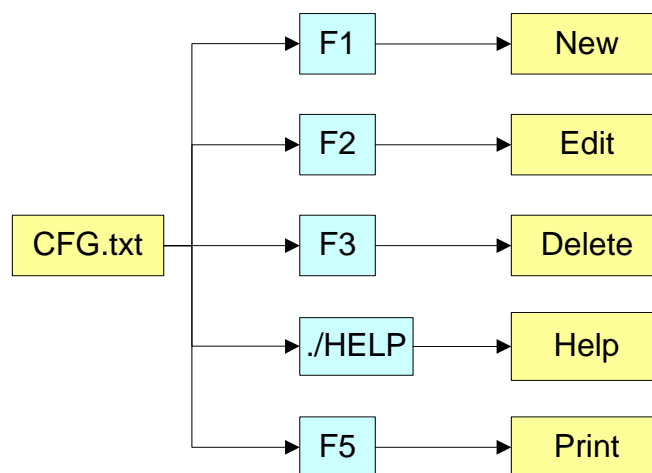
**ENTRY**

- Press **ENTER** to enter in the step.
- Select the eventual desired position through the arrow ▲ ▼ keys (or with the keyboard digit the position number).
- Press **F1** to enter the text in the desired position, or the first free position, if an already occupied position has been selected.
- The display shows “DESCRIPTION” and one can now enter the heading of the input text (up to 16 characters); press **ENTER** to confirm.
- The display shows “TEXT” and one can enter the contents of the input text (up to 32 characters); press **ENTER** to confirm.
- The display shows “THRESHOLD” and one can enter the maximum number of alphanumeric characters enterable in the field “TEXT”; press **ENTER** to confirm.
- The display shows “MANDATORY INPUT”, if one chooses “Enable” it is possible to exit from the input phase only if the text isn’t null; press **ENTER** to confirm.
- The display shows “ONLY VOID INPUT”; if one chooses “Enable” it is possible to modify the text only if it is null; press **ENTER** to confirm.
- **NOTE:** The threshold entered here defines also the field length for the compilation through the **F4** key in the weighing phase; if no text is inserted, the length is set at 32 characters.

**MODIFICATION**

- Press **ENTER** to enter in the step.
- Select the storage to be modified through the arrow ▲ ▼ keys (or with the keyboard digit the position number) and

- press **F2**.
- Modify the desired fields, listed in the previous section.
- **NOTE:** The text entered here defines also the field length for the compilation through the **F4** key in the weighing phase; if no text is inserted, the length is set at 32 characters.

## CANCELLATION

- Press **ENTER** to enter in the step.
- Select the storage to be cancelled through the arrow **▲ ▼** keys (or with the keyboard digit the position number) and press **F3**.
- The indicator requests a further confirmation: press **ENTER** to confirm or another key to cancel.

## PRINTING

- Press **ENTER** to enter in the step.
- Once inside it, press the **F5** key to print all the input texts. The LCD display shows the message "**PRINT ?**": confirm with the **ENTER** key to print the whole input texts' database.

## HELP

By pressing the **.HELP** key, it's possible to see the keys list used in the menu.  
The key list is automatically made. If you want to see the keys list, in manual mode, use the arrow key (F6 **▼** and F7 **▲**).

### << d.thrES >> DATA LENGTH THRESHOLD FROM READER

By pressing **ENTER** one can define a length (from 00 to 31) which conditions the storage of data ready by the third serial line (optional), for example through the bar code reader. If the datum has a length less or equal to the predefined one; it is stored in the first input text; otherwise it is stored in the second one.

**NOTE:** the function has been enabled on the serial port selected in the **SEtuP >> SEriAL >> rEAdEr** step, or on the PC KEYBOARD input, by selecting the "Reader" parameter in the **SEtuP >> PC.KEYb >> KEY.uSE** step.

### << tXt.i >> ENTRY OF HEADINGS

Up to 3 lines x 24 characters of text can be entered that will be printed if programmed in the printout formats (see blocks 372, 373, 374). The text entered will remain stored and printed until it is either cancelled or substituted.

### << CLr.rAM >> CANCELLATION OF THE BUFFERED RAM

The indicator has a buffered RAM memory (not volatile when power is removed) inside which is the database data, the input texts, the print formats, the heading.

The cancellation is not immediate; the indicator requests a further confirmation (the display shows "SURE?"): press **ENTER** to confirm; press another key to cancel.

**NOTE:** CALIBRATION DATAS ARE NOT CANCELLED.

### << dtb.PWd >> SET DATABASE ACCESS PASSWORD

By confirming the **ENABLED** setting one may insert a password of up to 5 digits, which will inhibit some parameters of the **ENTER** key menu and the entry/modification/cancellation of the databases; by setting **DISABLED**, this password is disabled.

See the section 12 in the user manual.

**NOTE:** The maximum enterable value is **65534**.

(!) diSAbl

### << tAMAG >> TAMAGOTCHI

One enters the "NUMBER of MONTHS" passed (2 digits, **MonthS** parameters), or the "NUMBER of the WEIGHS" made (5 digits, **WEiGh.** parameter) **since the last calibration**; after this, one is advised to recalibrate the instrument.

By pressing **ENTER** one passes to a submenu:

- **MonthS** >>> Setting of Months
- **WEiGh.** >>> Setting of Weighs
- **rESEt** >>> Clearing of Months and Weighs from the last calibrations

If you set the number of months and the weighing to zero, this function will be disabled; in any case it is possible to



activate a choice of the number of months (MAX 99) or the number of weighs (MAX 99999).

By confirming with **ENTER** on the "rESEt" step one sets at zero the number of months and weighs taken place since the last calibration made.

At start-up and every day at 11:00 o'clock, the indicator will be checking for the number of weighing and the number of months that have passed since the last calibration. If one of the values or both are equal or higher than the previously set values, the message "RECALIBRATE THE SCALE" appears in the LCD display and an intermitting sound is emitted. By pressing any key, the indicator will enter in the normal scale functioning mode.

**NOTE:** The number of weighs is increased when, after passing by instability, there is a stable weight and greater than 4 divisions on the scale.

(!) **MonthS 00; WEiGh. 00000.**

## << SEtuP >> SCALE CONFIGURATION

### << ConFiG >> METRIC PARAMETERS

If various scales are connected, the scale number to be configured will be requested; the configurations inside this menu must be made for each connected scale.

#### << EquAL >> EQUALIZATION (§)

See section "3.4 SCALE CALIBRATION"

(§) This step is visible only in case of more cells/channels in use.

#### << PArAM. >> PARAMETERS

##### << StAbiL >> FILTERING INTEGRATION

By pressing the **ENTER** key one accesses the selection of the type and degree of filter intervention for the stability of the weight indication:

<b>FLT 0 – 3</b>	simple weighing
<b>H.R.0 – 1</b>	high resolution and "A+B" mode
<b>DYN.0 – 1</b>	weight in motion (i.e. weighing animals)
<b>DOS.0 – 3</b>	dosage
<b>SLW.0 – 3</b>	rather unstable weight
<b>H.R.2 – 7</b>	high resolution and "A+B" mode
<b>DYN.2 – 3</b>	weight in motion (i.e. weighing animals)
<b>FLT.OFF</b>	disabled (i.e. digital load cell already filtered)
<b>FLT.AV2</b>	digital load cell
<b>R.ADC D</b>	digital load cell (with radio module)
<b>R.ADC S</b>	digital load cell (with radio module)
<b>CuStoM</b>	diagnostic to be used by the manufacturer

The higher the filter value, and greater is its intervention relative to the type of filter used.

(!) **CuStoM** for analogue cell type

(!) **FLT.AV2** for digital cell type

(\*) In case of approved instrument, one can select only **FLT 0...3, H.R.0, H.R.1, DYN.0, DYN.1.**

**<< (\*) Auto-0 >> AUTOZERO AT START-UP**

Automatic acquisition of the gross zero at start-up.



- Disabled

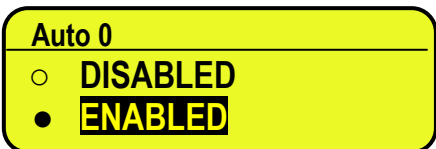

- Enabled

ENTER →

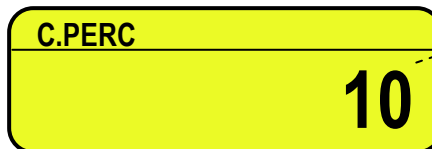
*Clearing percentage  
(blinking)*Set the clearing percentage in relation to the capacity  
(in between +/-1 and +/- 50 %).See section 3.4 (**USER MAN.REF.**) for details on the functioning.

(\*) with approved instrument:

- it's possible to set only the ENABLED, CYCLIC values. If DISABLED has been set, it's not possible to change it.
- by confirming the setting of ENABLED or CYCLIC it is possible to modify the clearing percentage between +/-1 and +/-10 %.

**(!) ENABLED, +/-10 %****<< (\*) 0.PErC >> ZERO FUNCTIONS IN WEIGHING PHASE**

Acquisition of the gross zero through the ZERO key.

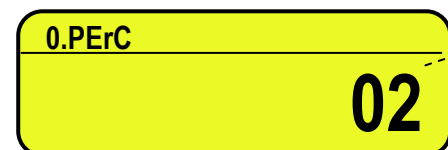
*Clearing percentage  
(blinking)*Set the clearing percentage in relation to the capacity (in between +/-1 and +/- 50 %).  
By entering the 0 value, it's possible to disable the ZERO functions in the weighing phase.See section 6 (**USER MAN.REF.**) for functioning details.

(\*) In case of approved instrument, the settable values are between 0 and 2.

**(!) +/-2 %****<< (\*) 0.trACk >> ZERO TRACKING**

This menu allows setting the zero tracking, in other words, the compensation parameter of the scale's thermal drift; the set value corresponds to the number of divisions that is reset in the fixed time of 1 second:

**TR. ½** +/- half division.**TR. ¼** +/- one fourth of a division.**TR. 1** +/- one division.**TR. 2** +/- two divisions.**TR. no** tracking disabled.**(!) TR. ½ (\*)** with APPROVED instrument it is possible to select just the **TR. no**, **TR. ½**, **TR. ¼** parameters.**<< (\*) diV.Stb >> DIVISIONS BY STABILITY**

In this step one enters the number of divisions by which the instrument detects the weight stability; the higher the number of divisions, less is the sensitivity, and consequently the stability is more easily detected. The possible values are 0...99. By setting the 0 value, the check is disabled.

**(!) 02**

(\*) with APPROVED instrument, the parameter is read-only.

**<< GrAV >> GRAVITY ZONE AND ZONE OF USE**

In this step one selects the gravitational acceleration value **of calibration and of use** of the instrument:

Manual entry of the g value: the instrument is ready for the manual entry of the gravitational acceleration value.

If one enters a wrong g value: the minimum decimal value is proposed (9,75001); by a wrong g value one intends a decimal number not including between 9,75001 and 9,84999 (included).

**(!) g = 9,80655**

(\*) with APPROVED instrument the parameter is read only.

**(\*) << CALib.>> SCALE CALIBRATION**

See section "3.4 SCALE CALIBRATION".

(\*) with APPROVED instrument the parameters inside of this step are read only.

**(\*) << 0.CALib. >> CALIBRATION OF ZERO**

See section "3.4 SCALE CALIBRATION".

(\*) In case of approved instrument the parameter is not displayed.

**(\*) << thEo.CA >> THEORETICAL CALIBRATION**

See section "3.4.7 THEORETICAL CALIBRATION".

(\*) In case of approved instrument the parameter is not displayed.

**(\*) << AdJ.CEL >> MANUAL ADJUSTMENT CELLS**

See section "3.4.5 ADJUSTMENT OF EQUALIZATION COEFFICIENT".

This parameter is visible only in case of various cells / channels forming the scale.

(\*) In case of approved instrument the parameter is not displayed.

**<< SEriAL >> SERIALS, PRINTOUTS, ETC...****<< PortS >> SERIAL CONFIGURATION**

By pressing **ENTER** it is possible to select the more suitable combination for the use of the three serial ports in the indicator hardware (**COM1, COM2, COM3**):

Parameter	COM 1	COM 2	COM 3
PC.Pr.AX	ComPC	ComPrn	ComAux
PC.AX.Pr	ComPC	ComAux	ComPrn
Pr.PC.AX	ComPrn	ComPC	ComAux
Pr.AX.PC	ComPrn	ComAux	ComPC
AX.PC.Pr	ComAux	ComPC	ComPrn
AX.Pr.PC	ComAux	ComPrn	ComPC

**(!) PC.Pr.AX**

**<< CoMPrn >> CONFIGURATION OF PRINTER SERIAL****<< bAud >> SET BAUD RATE**

By pressing the **ENTER** key one accesses the selection of the data transmission speed (measured in Baud = bit/second). The possible values are: 1200, 2400, 4800, 9600, 19200, 38400, 57600, 115200.

**(!) 9600**

**<< PAritY >> SET PARITY**

By pressing the **ENTER** key one accesses the selection of the parity bit type. The possible values are: None (absent parity bits), Odd (uneven parity bits) e Even (even parity bits).

**(!) None**

**<< Word >> SET WORD**

By pressing the **ENTER** key one accesses the selection of the number of data bits. The possible values are: 8 (8 data bits) and 7 (7 data bits). **(!) 8 bit**

**<< StoP b >> SET STOP BIT**

By pressing the **ENTER** key one can then select the number of stop bits. The possible values are: 1 (1 stop bit) and 2 (2 stop bits).

(!) **1 bit**

**<< CtS.St. >> SYNCHRONISM SIGNAL**

On the serial line set as COM.PRN the indicator can manage a synchronism signal.

- by using the dedicated CTS (Clear To Send) signal, if one uses the COM2 port, or
- by using the RX input, if one uses the COM1 or COM3 port (in this case, by enabling the function, this input will be no longer managed for other reception functions).

A device (like a printer) that is slow in processing the data received, can interrupt the transmission temporarily using this signal.

With synchronism signal active for a time greater than 10 seconds the indicator cancel the printing, it shows the message "PRINTER ERROR: CHECK THE CTS!" for a few seconds and returns to the weighing phase.

It is possible to select:

- |                 |   |                                      |
|-----------------|---|--------------------------------------|
| <b>NO.CTS</b>   | Disable   | (ITALORA WITTY280 and SMT280)        |
| <b>LOW</b>      | CTS active low  | (LP522/542, EPSON LX300, TM295, TPR) |
| <b>HIGH</b>     | CTS active high   | (DP190)                              |
| <b>EMUCTS</b>   | Emulation of CTS signal: one is asked to enter the number of characters (nChrS) using 3 digits, which will be transmitted upon each transmission; then one should enter the wait time in milliseconds (tiME), using 4 digits, from a transmission and the next one. |                                      |
| <b>XON/XOFF</b> | XON/XOFF control for the printer. Is necessary the insertion of the printer reset command (4 characters in decimal) and the decimal value of XON and XOFF character (17 and 19 of default).   |                                      |

(!) **LOW**

**<< SND.CTS >> SECOND CTS SIGNAL (§)**

This step decides if enables (**Enable**) second CTS signal used for 2 printers or not (**Disable**). See the previous step **<< CtS.St. >>**.

(§) the step is visible only if **COM2** is set on "PRN" and **LOW** or **HIGH** signal is enabled inside "CTS.ST." step.

(!) **Disable**

**<< Err.CtS >> CTS STATUS ERROR**

By enabling this error, it is possible to block in advance the print or totalisation function, if recalled with an already active synchronism signal (see previous step): the indicator display will shows the message "PRINTER ERROR: CHECK THE CTS!" for a few seconds and return to the weighing phase without carrying out the function.

Press F6/F7 to enable (**enabled**) or disable (**disabled**), and ENTER to confirm.

(!) **Disabled**

**<< PWrPrn >> PRINTER POWER SUPPLY**

This step regulates the "AUX" output voltage which is on the board (see the electrical scheme in section 8); one may select:

- |               |  |
|---------------|--|
| <b>PWrExt</b> | External power supply (AUX output active).   |
| <b>EXtoFF</b> | External auto-off power supply (AUX output always active; at the beginning of each printout some CR are sent as start-up characters, for a printer in energy saving mode). |
| <b>PWrint</b> | Internal power supply (AUX output active just when printing).  |

(!) **PWrint**

**<< ProtoC >> SELECTS PROTOCOL**

- |               |  |
|---------------|--|
| <b>norMAL</b> | Standard protocol;                     |
| <b>riPE 6</b> | Dini Argeo repeater;                   |
| <b>Alibi</b>  | Actually not used in this application; |
| <b>Cont.</b>  | Continuous transmission protocol.      |

For the protocol specifications, see section 5.4.

(!) **norMAL**

**<< CoM PC >> PC SERIAL CONFIGURATION****<< bAud >> SET BAUD RATE**

By pressing the **ENTER** key one accesses the selection of the data transmission speed (measured in Baud = bit/second). The possible values are: 1200, 2400, 4800, 9600, 19200, 38400, 57600, 115200.

**(!) 9600**

**<< PAritY >> SET PARITY**

By pressing the **ENTER** key one accesses the selection of the parity bit type. The possible values are: None (absent parity bits), Odd (uneven parity bits) e Even (even parity bits).

**(!) None**

**<< Word >> SET WORD**

By pressing the **ENTER** key one accesses the selection of the number of data bits. The possible values are: 8 (8 data bits) and 7 (7 data bits).

**(!) 8 bit**

**<< StoP b >> SET STOP BIT**

By pressing the **ENTER** key one can then select the number of stop bits. The possible values are: 1 (1 stop bit) and 2 (2 stop bits).

**(!) 1 bit**

**<< CtS.St. >> SYNCHRONISM SIGNAL**

On the serial line set as COM.PRN the indicator can manage a synchronism signal CTS (Clear To Send). A device (like a printer) that is slow in processing the data received, can interrupt the transmission temporarily using this signal.

It is possible to select:

**NO.CTS** Disable

**LOW** CTS active low

**HIGH** CTS active high

**EMUCTS** Emulation of CTS signal: one is asked to enter the number of characters (nChrS) using 3 digits, which will be transmitted upon each transmission; then one should enter the wait time in milliseconds (tiME), using 4 digits, from a transmission and the next one.

**(!) NO.CTS**

**<< Add.485 >> 485 ADDRESS**

By pressing **ENTER** it is possible to enter a 2 digit code (from 00 to 98) which identifies the instrument from the ones connected in the RS485 transmission mode.

**NOTE:** the 99 code is used as a broadcast address.

**(!) 00**

<< ProtoC >> SELECTS PROTOCOL

<b>StAnd</b>	Standard
<b>AFX</b>	AFOX
<b>riPE 6</b>	Dini Argeo 6-digit repeater
<b>riPLCd</b>	LCD repeater (for 3590E version)
<b>Mondir</b>	Uni-directional
<b>ALibi</b>	Actually not used in this application
<b>Modbus</b>	Modbus protocol
<b>Profi.b</b>	Profibus protocol
<b>b tYPE</b>	
<b>riP. b</b>	
<b>Eth.nEt</b>	Protocol Ethernet
<b>riP.b3</b>	
<b>riP.b4</b>	
<b>Coin</b>	Coin

For the protocol specifications, see section 5.4

(!) **StAnd**

<< PC.ModE >> TRANSMISSION TYPE

<b>rEquE.</b>	On request
<b>Cont.</b>	Continuous
<b>StAbiL</b>	On stability
<b>- 485 -</b>	485 mode
<b>AXLE</b>	Axle acquisition
<b>totAL</b>	Axle Total
<b>inPut</b>	In
<b>outPut</b>	Out
<b>End.CYC</b>	At the end of the in/out weighing cycle or of the single weigh.

For the transmission mode specifics, see section 5.5

(!) **rEquE.**

<< CoMAuX >> AUX SERIAL CONFIGURATION<< bAud >> SET BAUD RATE

By pressing **ENTER** one can select the data transmission speed (measured in Baud = bit/second). The possible values are: 1200, 2400, 4800, 9600, 19200, 38400, 57600, 115200.

(!) **9600**

<< PAritY >> SET PARITY

By pressing **ENTER** one can select the parity bit type. The possible values are: None (absent parity bit), Odd (uneven parity bit) and Even (even parity bit).

(!) **None**

<< Word >> SET WORD

By pressing **ENTER** one can select the number of data bits. The possible values are: 8 (8 data bits) and 7 (7 data bits).

(!) **8 bit**

<< StoP b >> SET STOP BIT

By pressing the **ENTER** key one can then select the number of stop bits. The possible values are: 1 (1 stop bit) and 2 (2 stop bits).

(!) **1 bit**

<< CtS.St. >> SYNCHRONISM SIGNAL

On the serial line set as COM.PRN the indicator can manage a synchronism signal CTS (Clear To Send). A device (like a printer) that is slow in processing the data received, can interrupt the transmission temporarily using this signal.

It is possible to select:

**NO.CTS** Disable

**LOW** CTS active low

**HIGH** CTS active high

**EMUCTS** Emulation of CTS signal: one is asked to enter the number of characters (nChrS) using 3 digits, which will be transmitted upon each transmission; then one should enter the wait time in milliseconds (tiME), using 4 digits, from a transmission and the next one.

(!) **NO.CTS**

<< ProtoC >> SELECTS PROTOCOL

**nonE** No protocol

**Cont.** Continuous transmission

**riPE 6** Dini Argeo 6-digit repeater

**riPEdC** DC Repeater

**Eth.nEt** Protocol Ethernet

**Coin** Coin

(!) **nonE**

<< rAdEr >> READER PROTOCOL

Enabling data reception from external reader (See relative manual)

**DISABLE** data reception disabled

**COM.AUX** protocol enabled on the ComAux

**COM.PRN** protocol enabled on the ComPrn

(!) **DISABLE**

<< r71.rEP >> R71 REPEATER

If the R71620 is connected to the indicator, through this step it is possible to enable the dedicated protocol, for the serial ports set with the "riPE 6" protocol.

**DISABLED**

**ENABLED**

(!) **DISABLED**

<< Prn.FMt >> PRINT CONFIGURATION

Through this step one can configure up to 30 print formats directly from the indicator.

In this step it is possible to choose the number of format to be configured; therefore enter, modify or eliminate the print blocks following the instructions shown in section **7 PROGRAMMING THE PRINTOUTS**.

<< tErMin >> SET TERMINATOR TYPE

When connecting a printer it is possible to define the end of the print line, in the print blocks that provide the terminator print (indication +T, see 7.3 section)

**Cr** TERMINATOR CR (character 13 from ASCII table)

**Cr LF** TERMINATOR CR LF (character 13 and character 10 from ASCII table)

**LF** TERMINATOR LF (character 10 from ASCII table)

**no.tErM** NO TERMINATOR (for Dini Argeo printiers, with standard print by Dinitools TM)

(!) **LF**

<< dEF.Prn >> PRINTOUT DEFAULT

By pressing **ENTER** one is asked to confirm the activation of the default printouts: the display shows "SurE?": press **ENTER** again to confirm or another key to cancel the operation.

**The printout default is valid only for TPR printer.**

**WARNING:** By enabling the printouts, all the formatted print formats will be CANCELLED and the first 11 will be SUBSTITUTED by the default formats which automatically will be linked to the 11 print functions.

**<< Anout >> ANALOGUE OUTPUT (OPTIONAL)**

If various scales are connected (see **nuM.SCA** parameter), the scale number to be configured will be requested; the configurations inside this menu must be made for each connected scale.

**<< SLOt >> SLOT SELECTION**

One selects the SLOT to be used with the analogue output: SLOT 1 or SLOT2.

**<< ModE >> OPERATING MODE**

(!) **AO G** = analogue output on the gross weight  
**AO n** = analogue output on the net weight

**<< AoMA >> MAXIMUM VALUE**

Setting of the maximum value of the analogue output.

**<< AoZE >> VALORE ZERO BILANCIA**

Setting of the analogue output value when the scale displays zero weight.

**<< AoMi >> MINIMUM VALUE**

Setting of the minimum value of the analogue output.

**See the “7. ANALOGUE OUTPUT” for configuring.**

**<< inPutS >> INPUT CONFIGURATION**

The indicator has 2 inputs on the main board, 6 on the optional expansion board, which may take on the meaning of a specific function key or of any scale function key, among those available; it is therefore possible to emulate a few keys through the corresponding input.

**in. 1 INPUT 1**

<b>None</b>	NO INPUT
<b>TARE</b>	TARE KEY
<b>2nd F</b>	2nd F KEY
<b>Fn</b>	Fn KEY
<b>POINT</b>	POINT KEY
<b>C</b>	C KEY
<b>F1</b>	F1 KEY
<b>F2</b>	F2 KEY
<b>F3</b>	F3 KEY
<b>F4</b>	F4 KEY
<b>F5</b>	F5 KEY
<b>F6</b>	F6 KEY
<b>F7</b>	F7 KEY
<b>F8</b>	F8 KEY
<b>F9</b>	F9 KEY
<b>F10</b>	F10 KEY
<b>- 0 -</b>	NUMERICAL ZERO KEY
<b>- 1 -</b>	ONE KEY
<b>- 2 -</b>	TWO KEY
<b>- 3 -</b>	THREE KEY
<b>- 4 -</b>	FOUR KEY
<b>- 5 -</b>	FIVE KEY
<b>- 6 -</b>	SIX KEY
<b>- 7 -</b>	SEVEN KEY
<b>- 8 -</b>	EIGHT KEY
<b>- 9 -</b>	NINE KEY
<b>PLt – 1</b>	ENABLE SCALE 1



<b>LOC.IN</b>	KEYBOARD LOCK
<b>OFF</b>	TURNING OFF THE INDICATOR
<b>-OK-</b>	OK MESSAGE
<b>ERROR</b>	ERROR MESSAGE
<b>READY</b>	READY MESSAGE
<b>START</b>	START MESSAGE
<b>STOP</b>	STOP MESSAGE
<b>RL.OFF</b>	SETS ALL THE RELAYS AT OFF
<b>LNG.KEY</b>	SETS KEY PRESSED AT LENGTH
<b>LEVEL</b>	SETS LEVEL CHECK
<b>R.START</b>	CYCLE MANAGEMENT ON THE RELAYS (dosage)
<b>AUT.CYC</b>	By setting zero seconds in the <b>F.Mode &gt;&gt; total &gt;&gt; dyn.CGF &gt;&gt; tiME W</b> step or in the <b>F.Mode &gt;&gt; total &gt;&gt; StA.CFG &gt;&gt; tiME W</b> step (INTERVAL BETWEEN CYCLES), and by using this setting, the beginning and the end of the automatic weighing cycle are defined, respectively, from the enabling and disabling of the input itself.

(!) nonE

The same configurations are valid for:

in. 2 INPUT 2

in. 3 EXPANSION BOARD

in. 4 EXPANSION BOARD

in. 5 EXPANSION BOARD

in. 6 EXPANSION BOARD

in. 7 EXPANSION BOARD

in. 8 EXPANSION BOARD

## << outPut >> OUTPUT CONFIGURATION

The indicator has 4 outputs on the main board and 12 outputs on the optional expansion board; through this step one configures the functioning of each relay.

See the "15.4 SET POINT FUNCTION" section in the user manual for the functioning mode specifications.

### << r.ConF >> OUTPUTS' CONFIGURATION

In this step it is possible to configure the normal status, the switching condition and the functioning mode for each output.

#### << rL. 1 >> OUTPUT 1 (OUT1)

##### << no/nC >> NO/NC CONTACTS

By pressing **ENTER** one sets the status of the output after the instrument start-up: normally open (**n.o.**) or normally closed (**n.C.**).

**NOTE:** with indicator turned off, the status of the output is normally open.

(!) n.o.

##### << onStAt >> SWITCHING CONDITION

By pressing **ENTER** one sets the output activation condition:

**drCt** DIRECT: it is activated as soon as the weight reaches the set threshold, (independently from the stability), and it is deactivated as soon as it goes under the disabling threshold.

**StbL** UPON STABILITY: it is activated in the moment in which the weight, after reaching the set activation threshold, becomes stable, and it is deactivated in the moment in which the weight goes below the set disabling threshold, it becomes stable.

(!) drCt

**<< rL.iSt >> HYSTERESIS**

This step allows selecting the outputs functioning mode with or without hysteresis:

**iSt.on** functioning with hysteresis  
**iSt.oFF** functioning without hysteresis  
**(!) iSt.oFF**

**<< rLFunC >> FUNCTION**

This step allows selecting the output functioning mode:

**nonE** NO FUNCTIONING (disabled).  
**GroSS** GROSS SET POINT (activation of the output on the gross weight).  
**nEt** NET SET POINT (activation of the output on the net weight).  
**Gro.0** 0 GROSS (activation of the output on the gross weight at 0).  
**nEt.0** 0 NET (activation of the output on the net weight at 0).  
**Motion** INSTABILITY (activation of the output upon weight instability).  
**totAL** TOTALISATION (activation of the input/output cycle end or single weigh).  
**t.W.1** PARTIAL TOTAL (activation of the output on the partial total + net weight on the scale).  
**t.W.2** GENERAL TOTAL (activation of the output on the general total + net weight on the scale).  
**t.W.3** GRAND TOTAL (activation of the output on the grand total + net weight on the scale).  
**nEt.nEG** FUNCTIONING ON THE NEGATIVE WEIGHT (activation on the net negative weight).  
**in-out** OPERATION MADE (enabling of the output at the end of each input or output weigh).  
**WEiGh** WEIGHT ACQUISITION (enabling of the output upon each weight acquisition).  
**Aut.WEi** Enabling of the weight acquisition (only for the automatic axle weighing).  
**Aut.Err** Enabling of the weight acquisition error (only for the automatic axle weighing).  
**t.LiGht** FUNCTIONING WITH TRAFFIC LIGHT (see the user manual for the functioning).  
**tot.Wt** AXLE TOTAL (enabling of the relay when the setpoint set has been reached).  
**(!) nonE**

The same configurations are valid for:

**rL. 2** OUTPUT 2 (OUT2)  
**rL. 3** OUTPUT 3 (OUT3)  
**rL. 4** OUTPUT 4 (OUT4)  
**rL. 5** OUTPUT 5 (OUT5), EXPANSION BOARD  
**rL. 6** OUTPUT 6 (OUT6), EXPANSION BOARD  
**rL. 7** OUTPUT 7 (OUT7), EXPANSION BOARD  
**rL. 8** OUTPUT 8 (OUT8), EXPANSION BOARD  
**rL. 9** OUTPUT 9 (OUT9), EXPANSION BOARD  
**rL. 10** OUTPUT 10 (OUT10), EXPANSION BOARD  
**rL. 11** OUTPUT 11 (OUT11), EXPANSION BOARD  
**rL. 12** OUTPUT 12 (OUT12), EXPANSION BOARD  
**rL. 13** OUTPUT 13 (OUT13), EXPANSION BOARD  
**rL. 14** OUTPUT 14 (OUT14), EXPANSION BOARD  
**rL. 15** OUTPUT 15 (OUT15), EXPANSION BOARD  
**rL. 16** OUTPUT 16 (OUT16), EXPANSION BOARD

**<< r.ModE >> OUTPUTS' CONFIGURATION**

**Normal** The check is always made on all the configured outputs; therefore each output is independently (its enabling does not provoke the disabling of the others).

**EXCLUS** Starting from the last output up to the first its activation excludes the check on the previous ones (the activation provokes the disabling of the previous outputs) and its disabling reenables it.

**(!) Normal**

**<< inF.rEd >> REMOTE CONTROL CONFIGURATION**

Entering the step one can choose one of four types of remote control shown:

- **None** (no remote control enabled)
- **IR 4** (4-key infrared remote control)
- **IR 18** (18-key infrared remote control)
- **IR 19** (19-key infrared remote control)
- **RD 6** (6-key radio remote control)
- **RD.BR 6** (6-key radio broadcast remote control)

The remote control keys repeat the keys' functions (both the ones obtained with a SHORT pressing as well as those with a LONG pressing).

If the weight indicator provides for a **4-key remote control** or a **6-key remote control** (optional) it's possible to personalise the configuration of the keys of the infrared ray remote control; it may be done as follows:

**KEY 1 key 1 ("Zero" on the remote control)**

<b>None</b>	NO INPUT
<b>TARE</b>	TARE KEY
<b>2nd F</b>	2nd F KEY
<b>Fn</b>	Fn KEY
<b>POINT</b>	POINT KEY
<b>C</b>	C KEY
<b>F1</b>	F1 KEY
<b>F2</b>	F2 KEY
<b>F3</b>	F3 KEY
<b>F4</b>	F4 KEY
<b>F5</b>	F5 KEY
<b>F6</b>	F6 KEY
<b>F7</b>	F7 KEY
<b>F8</b>	F8 KEY
<b>F9</b>	F9 KEY
<b>F10</b>	F10 KEY
<b>- 0 -</b>	NUMERICAL ZERO KEY
<b>- 1 -</b>	ONE KEY
<b>- 2 -</b>	TWO KEY
<b>- 3 -</b>	THREE KEY
<b>- 4 -</b>	FOUR KEY
<b>- 5 -</b>	FIVE KEY
<b>- 6 -</b>	SIX KEY
<b>- 7 -</b>	SEVEN KEY
<b>- 8 -</b>	EIGHT KEY
<b>- 9 -</b>	NINE KEY
<b>LOC.IN</b>	KEYBOARD LOCK
<b>OFF</b>	TURNING OFF THE INDICATOR
<b>-OK-</b>	OK MESSAGE
<b>ERROR</b>	ERROR MESSAGE
<b>READY</b>	READY MESSAGE
<b>START</b>	START MESSAGE
<b>STOP</b>	STOP MESSAGE
<b>RL.OFF</b>	SETS ALL THE RELAYS AT OFF
<b>LNG.KEY</b>	SETS KEY PRESSED AT LENGTH
<b>LEVEL</b>	SETS LEVEL CHECK

(!) nonE

The same configurations are valid for:

**KEY 2 key 2 (“Tare” on the remote control)**

**KEY 3 key 3 (“F1 Mode” on the remote control)**

**KEY 4 key 4 (“F2 Print” on the remote control)**

If the weight indicator provides for a **18-key remote control** (optional) it's possible to choose the configuration of the keys of the infrared ray remote control (**USER MAN.REF**).

**NOTE:** The function of the prolonged pressure of the keys is not repeatable on the remote control.

### << **tArE t** >> TARE LOCK/UNLOCK

**Unlock** LOCKED TARE

**Lock** UNLOCKED TARE

**Disable** DISABLED TARE

See the section 7.5 “TARE LOCKED/UNLOCKED” in the user manual for the functioning specifics.

**NOTE:** during the weighing it is possible to lock / unlock the tare by pressing at length the **F5** key.

(!) **LoCk**

### << **ZOOM.W** >> WEIGHT ZOOM (§)

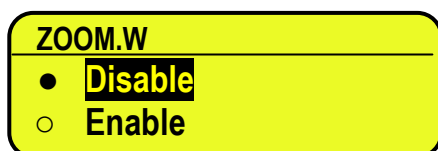

- Disable

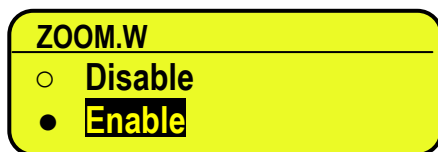

- Enable

ENTER →

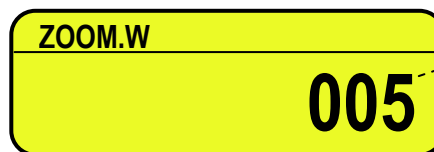

Activation delay  
(blinking)

Insert the activation delay (included between 0 and 255 sec.).

See section 5.1 (**USER MAN.REF.**) for the functioning details.

(!) **Enable, 005 sec.**

(§) This step is visible only in case of CPWE indicator.

### << **PoW.oFF** >> AUTO SWITCH OFF

One enables/disables the auto switch-off after the scale is not used for 5 minutes, with plate unloaded.

**ENABLED**

**DISABLED**

(!) **DISABLED**

### << **bt.StAt** >> BATTERY LEVEL INDICATION

One selects whether to enable or disable the software check of the battery charge level: each time that the charge goes down of a level, it is notified through the symbols on the LCD display (battery icon). See section 5.3 **USER MAN.REF.**

**ENABLED**

**DISABLED**

**NOTE:** by enabling the indication of the battery level, the backlight is automatically managed.

(!) **DISABLED**

**<< baCkuP >> INSTRUMENT DATA BACKUP**

By pressing **ENTER** the indicator display shows **SurE?**: press the **ENTER** key to confirm or **C** to cancel the operation. In the default steps: standard default, technical default, clearing of buffered ram, prints default or keys default, if a backup of the data is present, is asked if one wants to execute the normal default by pressing the **ENTER** key or to restore the saved data by pressing the **F1** key.

**<< dFLt >> DEFAULT STANDARD**

By pressing **ENTER** the indicator activates the default parameters (shown in bold and preceded by the exclamation point at the end of each step) and the standard printouts; the display shows **SURE?**: press **ENTER** to confirm or **C** to cancel the operation.

**NOTE: THE CALIBRATION, THE DATABASES, THE INPUT TEXTS AND THE HEADINGS ARE NOT DELETED.**

**<< dFLt.t >> TECHNICAL DEFAULT (\*)**

By pressing **ENTER** the indicator activates the default parameters (shown in bold and preceded by an exclamation point at the end of each step), the default printouts, initialises the database and the alibi memory, cancels the input texts, the heading and **THE CALIBRATION**; the display shows **SurE?**: press the **ENTER** key to confirm or **C** to cancel the operation.

(\*) In case of approved instrument the step is not accessible.

**<< PWd.SET >> SET ACCESS PASSWORD TO SET-UP ENVIRONMENT**

One configures whether to enable or disable the access password to the technical menu:

**ENABLED**

**DISABLED**

By selecting **ENABLED**, the instrument predisposes itself for the password entry, made up of up to 5 digits; when finished entering confirm with **ENTER**.

The settable values go from 0 to 65534.

See section 3 for the functioning specifics.

(!) **DISABLED**

**<< ini.AL >> INITIALIZES ALIBI MEMORY (\*)**

The initialisation cancels all the data stored in the Alibi memory; by pressing **ENTER** one is asked to confirm the operation. The display shows **SURE?**; press **ENTER** again to confirm or another key to cancel.

At the end the "oK" message appears if the operation is made with success; otherwise the "Err" message is displayed.

(\*) In case of approved instrument the parameter is not accessible.

**<< dSALE >> DIRECT SALE (\*)**

- **NO** limitations disabled

- **YES** limitations enabled

Refer to the user manual for the functioning description (**USER MAN.REF.**).

(!) **NO**

(\*) In case of approved instrument the parameter is not accessible.

**<< PC.KEYb >> PC KEYBOARD CONFIGURATION****<< KEY.uSE >> USE OF PC KEYBOARD INPUT**

**Normal** Use of the external PC keyboard (see in the user manual section 4.6).

**READER** Enabling data reception from external reader (See relative manual)

(!) **Normal**

<< LAYout >> EXTERNAL PC KEYBOARD LANGUAGE

ENGLISH American / English  
 DEUTSCH German  
 FRANCAIS French  
 ITALIANO Italian  
 (!) ENGLISH

<< diAG. >> DIAGNOSTICS MENU

It's a submenu inside of which it is possible to check the software and hardware components of the scale, accessible also during the weighing, keeping the **F4** key pressed at length.

<< PrG.UEr >> FIRMWARE

Software version check.

<< WEiGht >> WEGHT

By pressing **ENTER** the display shows:

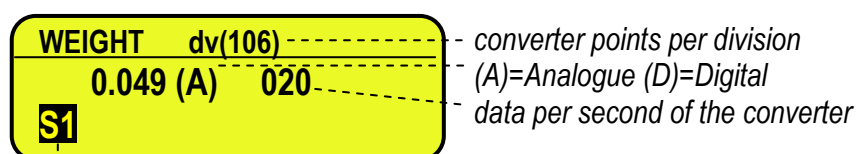

Checked scale

If various scales are connected independently by pressing the F6 / F7 keys it is possible to select the scale to be checked.

By pressing F5, it is possible to test the minimum value, present value and maximum value of the weight.

<< MiLLiV >> MILLIVOLT

Check of the load cell signal in millivolts, in three decimals.

By pressing **ENTER** the display shows:



Checked channel / digital load cell (With the DGX type of cells, it is the channel inside the DGX)

Checked scale

If various scales are connected independently by pressing the F6 / F7 keys it is possible to select the scale to be checked.

By pressing the F8 / F9 keys it is possible to move on the selection of the channel or the DGX (only with DGX type of cells); the display indicates always the active selection:

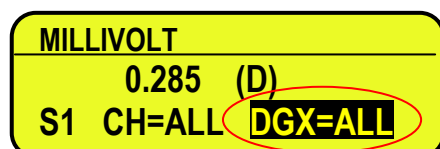

By pressing always the F6 / F7 keys it is possible to select the value of the active selection.

In the case the load cell is not connected or faulty, or the A/D converter is faulty, it is possible that floating values are shown, or the message "Err.C.XX" appears (in which XX is the number of channel / digital load cell on which the faulty is detected), if the signal exceed the underload / overload value of the converter.

To check if the A/D converter is faulty, disconnect the channel on which the faulty is detected and make a short between SIG+ and SIG-; with non faulty A/D converter a mV value proxime to 0.000 will be displayed.

By pressing F5, it is possible to test the minimum value, present value and maximum value of the millivolt

**<< ADC POINTS >> CONVERTER POINTS**

Check of the A/D converter points.

By pressing **ENTER** the display shows:

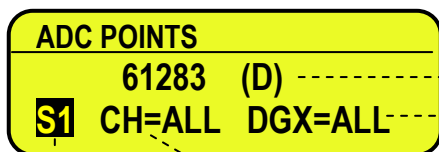

A/D converter points and type of cells: (A)=Analogue, (D)=Digital

Checked DGX (only with DGX type of cells)

Checked channel / digital load cell (With the DGX type of cells, it is the channel inside the DGX)

Checked scale

If various scales are connected independently by pressing the F6 / F7 keys it is possible to select the scale to be checked.

By pressing the F8 / F9 keys it is possible to move on the selection of the channel or the DGX (only with DGX type of cells); the display indicates always the active selection:

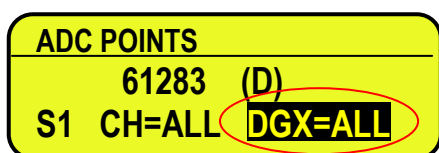

By pressing always the F6 / F7 keys it is possible to select the value of the active selection.

In the case the load cell is not connected or faulty, or the A/D converter is faulty, it is possible that floating values are shown, or the message "Err.C.XX" appears (in which XX is the number of channel / digital load cell on which the faulty is detected), if the signal exceed the underload / overload value of the converter.

To check if the A/D converter is faulty, disconnect the channel on which the faulty is detected and make a short between SIG+ and SIG-; with non faulty A/D converter a number of point proxime to 0 will be displayed.

By pressing F5, it is possible to test the minimum value, present value and maximum value of the adc points

**<< diSPLA >> DISPLAY**

By pressing **ENTER** the instrument shows the display version.

By pressing a key all the leds (in the 3590E version) and LCD display pixels turn on for some seconds, after that the indicator exit automatically from the step.

**<< kEyb. >> KEYBOARD**

By pressing **ENTER** the instrument displays 0; by pressing the keys one at a time, the relative codes are rebrought to the display. One exits pressing the same key three times.

**<< CtS.St. >> CTS STATUS**

By pressing **ENTER** the CTS signal type of the connected printer is shown on the display.

If the second CTS is enabled is possible scroll up and down with the rows to see the status of both CTS.

**<< b.LEVE >> BATTERY LEVEL**

By pressing **ENTER** one views on the display the value of the battery input on the motherboard, read by the analog-digital converter.

**<< PoWEr >> POWER SUPPLY VOLTAGE**

By pressing **ENTER** the display shows the value of the power adapter input on the motherboard, read by the analogue-digital converter.

**<< rELE >> RELAY TEST**

By pressing **ENTER** it is possible to test all the available relays; by selecting these one at a time with the ▲ ▼ arrow

keys, these are activated:

RL.01	OUT1	
...		Relay of the main board.
RL.04	OUT4	
RL.05	OUT5	
...		Relay of the expansion board (optional).
RL.16	OUT16	

### << inPutS >> INPUT TEST

By pressing **ENTER** it's possible to test the status of the inputs; the display will show:

INPUTS							
1	2	3	4	5	6	7	8
0	0	0	0	0	0	0	0

in which the number on the first line identifies the input:

1	IN1	
		Inputs of the motherboard
2	IN2	
3	IN3	
...		Inputs of the expansion board
8	IN8	

and the number each input corresponds to its status:

0 = disabled;  
1 = enabled.

### << Anout >> ANALOGUE OUTPUT

If the instrument is fitted with the analogue output, through this step one can test if the values of the D/A converter (to be entered at time of calibration) correspond with the relative values of the analogue output (in voltage or in current), see section 6.

By pressing **ENTER** the display shows 0; enter a value between 0 and 65535 and confirm with **ENTER**; the instrument will supply the corresponding analogue value in output.

To exit the test confirm twice with **ENTER** the same entered value.

### << SEr. >> SERIAL PORTS TEST

By pressing **ENTER** it's possible to redirect the data received by any serial port, on other serial ports.

### << SEr.nuM >> SERIAL NUMBER

Diagnostics check for use of the manufacturer.

### << P.teSt >> PRINT TEST

With this feature you can print all print formats of the instrument. By pressing **ENTER** the step it is asked which format to print. If you enter the 0 value, all print formats are printed in sequence.

### << EU.LoG >> EVENT LOG VIEWER

The instrument stores the following types of events:

- Metric event (calibration, equalization)
- Battery event (on, off, change of power, ...)
- Keyboard event (pressed keys)



- Setup event (by default, to restore from backup, save setup, ...)
- Firmware update event (firmware update)

For each type of event the last 10 events are stored with date/time In the function you can select what type of event is displayed and scroll the last 10 events. The F5 key is to be pressed in order to print the list.

### 3.3 CONFIGURATION OF THE DYNAMIC / STATIC PARAMETERS (STEP << TOTAL >>)

#### <<AXLE W>> AXLES WEIGHING MODE

**MANUAL** (MANUAL axle acquisition)

**DYNAMIC** (AUTOMATIC DYNAMIC axle acquisition)

**STATIC** (AUTOMATIC STATIC axle acquisition)

(!) **DYNAMIC**

#### <<in.out>> ENABLING INPUT / OUTPUT WEIGHING

- **ENABLE** >> Enabled

- **DISABL** >> Disabled

(!) **ENABLE**

#### <<i.o.SEL>> SELECTION OF INPUT/OUTPUT WEIGH DIRECTION (§)

- **BEFORE** input/output selection possible only before starting a weighing cycle.

- **BEF.AFT** input/output selection possible both before or after a weighing cycle is carried out.

(!) **BEFORE**

(§) This step is visible only if the **F.ModE** >> **totAL** >> **AXLE W** parameter is set on **DYNAMI** or **STATIC**

#### <<dYn.CFG>> DYNAMIC WEIGHING CONFIGURATION (§)

(§) This step is visible only if the **F.ModE** >> **totAL** >> **AXLE W** parameter is set on **DYNAMI**

#### **Min.WEi** MINIMUM AXLE WEIGHT

Minimum threshold which the weight must surpass in order to enable the weigh start check; the same threshold ends the weigh (if not yet ended) and reenables the instrument for the following weighs, after the weigh has gone below it.

(!) **750**

#### **n.SMPLS** NUMBER OF AVERAGE WEIGHT SAMPLES

This is the number of acquired weights for the calculation of the average weight (from 01 to 99).

Set low values if the weight is unstable or if a high weighing speed is requested.

It is possible to set higher values if the weight is stable, improving the weigh accuracy.

(!) **30**

#### **tiME W** INTERVAL BETWEEN WEIGHING CYCLES (in seconds, from 0 to 255.)

Equal to 0 weighing cycles managed with optoisolated input

Greater than 0 the weighing cycle is ended when the seconds set in the unloaded scale condition (average weight under the minimum weight of the axle) have passed

(!) **10**

#### **SKIP B** BEGINNING AXLES TO SKIP

Number of axles to not be totalised at the beginning of the cycle. See section 13.5 of the user manual.

(!) **00**

#### **SKIP E** ENDING AXLES TO SKIP

Number of axles to not be totalised at the end of the cycle. See section 13.5 of the user manual.

(!) **00**

**ERR.EN ENABLING AXLES ACQUISITION ERROR**

If **ENABLED**, the instrument display the axle error when it doesn't catch the "stable" weight of the axle, if **DISABLED**, when the "stable " weight is not found, the instrument take the first peak (of the weight) and take them as axlen weight.  
 (!) **ENABLED**

**SPEED SPEED LIMIT OVER THE PLATFORM**

Limits of the speed that the trucks can reach on the platform (during the weighing operations) in order to carry out optimal results in the weighing in motion.

(!) **01 km/h**

**TIM.OUT TIME OUT AXLE ACQUISITION**

Time between the acquisition of the axles through the platforms before show an error of acquisition axle.

(!) **005.00**

**PL.WIDT PLATFORM WIDTH**

Width of the platform (weighing area) in order to calculate the correctly vehicle speed.

(!) **000 cm**

**<<StA.CFG>> STATIC WEIGHING CONFIGURATION (§)**

(§)This step is visible only if the **F.ModE >> totAL >> AXLE W** parameter is set on **StAtiC**

**Min.WEi MINIMUM AXLE WEIGHT**

Minimum threshold which the weight must surpass in order to enable the weigh start check; the same threshold ends the weigh (if not yet ended) and reenables the instrument for the following weighs, after the weigh has gone below it.

(!) **750**

**STAB.TM STABILITY INTERVAL**

Time interval (in seconds, with a decimal) for which the weight must remain stable so that it is acquired; values from 0,01 to 100,0.

(!) **001.00**

**tiME W INTERVAL BETWEEN WEIGHING CYCLES (in seconds, from 0 to 255.)**

Equal to 0 weighing cycles managed with optoisolated input

Greater than 0 the weighing cycle is ended when the seconds set in the unloaded scale condition (average weight under the minimum weight of the axle) have passed

(!) **10**

**SKIP B BEGINNING AXLES TO SKIP**

Number of axles to not be totalised at the beginning of the cycle. See section 13.5 of the user manual.

(!) **00**

**SKIP E ENDING AXLES TO SKIP**

Number of axles to not be totalised at the end of the cycle. See section 13.5 of the user manual.

(!) **00**

**ERR.EN ENABLING AXLES ACQUISITION ERROR**

If **ENABLED**, the instrument display the axle error when it doesn't catch the "stable" weight of the axle, if **DISABLED**, when the "stable " weight is not found, the instrument take the first peak (of the weight) and take them as axlen weight.

(!) **ENABLED**

**TIM.OUT TIME OUT AXLE ACQUISITION**

Time between the acquisition of the axles through the platforms before show an error of acquisition axle.

(!) **005.00**

<< WEi.MEM >> TYPE OF INPUT WEIGH MEMORISATION

- **WEI.CODE** ID CODE
  - **PLATE** LICENSE PLATE
- (!) **WEI.CODE**

<< Pro.LSt >> LIST OF PROGRESSIVE WEIGHS (only for weighing through ID CODE)

If this parameter is **DISABLED**, each input weigh is linked to the lowest ID code available; if it is **ENABLED**, the ID code following the last input weigh is linked to it.

(!) **DISABLED**

<< t.ModE >> TYPE OF TOTALISATION

It is possible to select the type of totalisation:

- **MANUAL** manual totaliser (reenabling according to how the **rEACt** "REENABLINGS" step is set.
- **ALWAYS** totaliser always (always active).

(!) **MANUAL**

<< rESEt >> CONFIRM RESET

It is possible to select the automatic resetting of the totals when these are printed (**Disable**) or the resetting upon request (**Enable**).

(!) **ENABLE**

<< Add.tAr >> ADDITIONAL TARE

In this step one can enable (**ENABLED**) or disable (**DISABLED**) the request to enter an additional tare, at the moment of the output weigh execution. (**USER MAN.REF.**).

(!) **DISABLED**

<< A.inout >> AUTOMATIC INPUT / OUTPUT WEIGHT

In this step you can enable (**ENABLED**) or disable (**DISABLED**) automatic input output function or print (**SIMPLE PRINTOUT**) when vehicle is selected. This step is appropriate for the SELF SERVICE with badge reader.

In this way when you swipe the badge the indicator identify the veichle and it executes automatically the setted printout (input/output or simple printout). (**REF.NOT.U.**)

(!) **DISABLED**

**<< SELF.C >> SELF-SERVICE CONFIGURATION**

This function is visible and it can operate only if A.InOUT is enable or Coin protocol is enabled and includes these step to configure self service mode:

**<< R.S.WGHT >> WEIGHT RANGE TO HIDE:** If weight is greater then this weight, the instrument show ----- until something enable it. For example with badge or coin.

(!) 000000 kg

**<< DF.WGHT >> WEIGHT DIFFERENCE FOR END WEIGHING:** When the operation is complete, if the weight change of this quantity the display show -----.

(!) 000000 kg

**<< R.AUTO.0 >> WEIGHING RANGE FOR AUTO ZERO:** If the weight remain into this range, is stable and different from zero, the instrument automatically executes a zero.

(!) 000000 kg

**<< T.AUTO.0 >> TIME FOR AUTOZERO:** Time to wait before execute an automatic zero.

(!) 000000 sec

**<< T.STABI >> TIME STABILITY:** Time to wait before to consider the weight stable.

(!) 01 sec

**<< T.END >> TIME END OPERATION:** Time MAX to wait before to consider however the current procedure finished.

(!) 000000 sec

**<< T.MONEY >> TIME MAX WAIT MONEY:** (only if coin protocol enabled) time MAX to wait a coin before to consider however the current procedure finished.

(!) 000000 sec

**<< LOCK.K >> LOCK KEYBOARD:** If enabled lock all key.

(!) DISABLED

### 3.4 CALIBRATION OF THE SCALE

In case of various connected scales, each of them must be calibrated on its own, with its own capacity, division and unit of measure.

In case of various digital cells / channels, in addition to the calibration, one must carry out the equalisation.

#### 3.4.1 CALIBRATION PROCEDURE

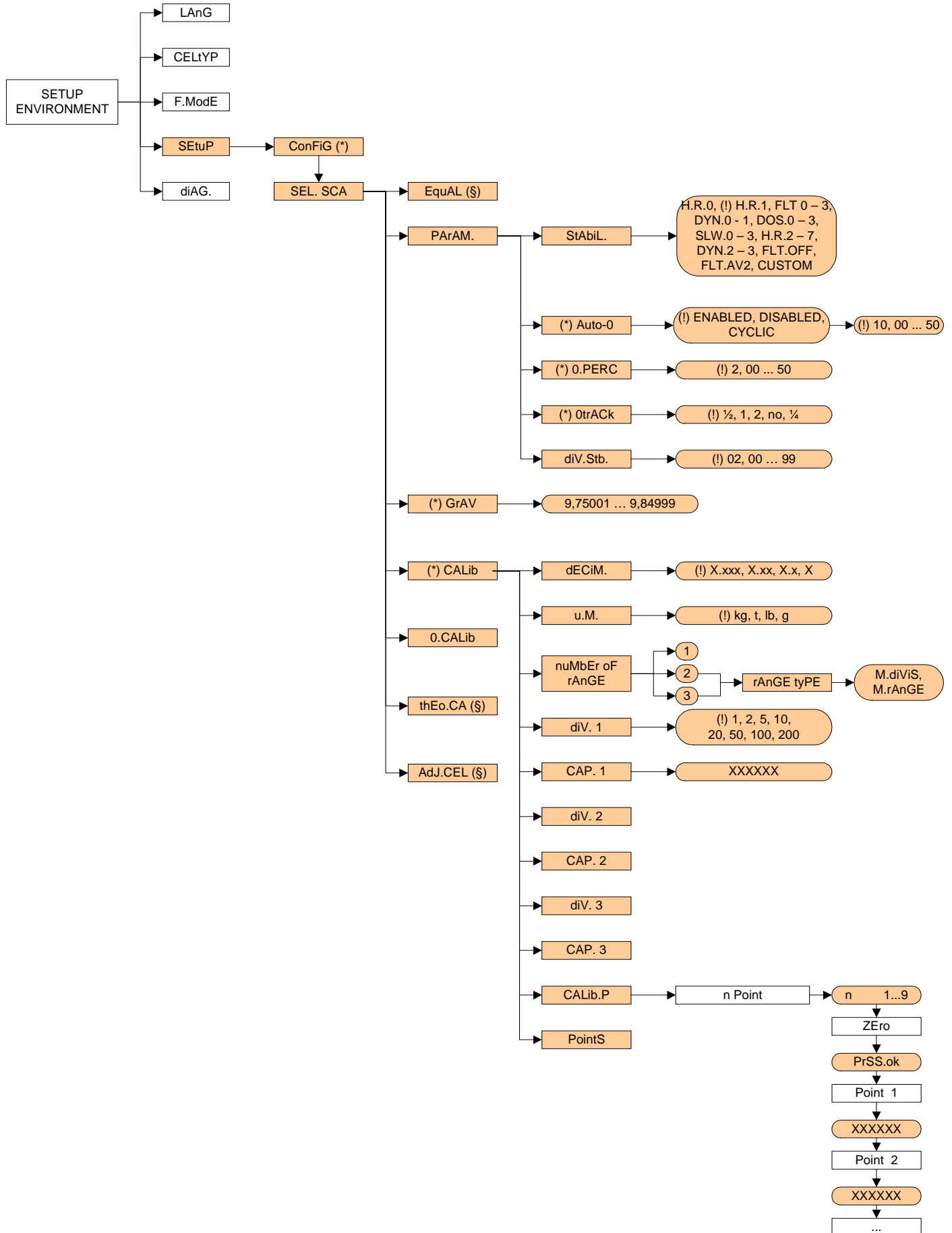

- 1) Enter the Setup of the instrument;  
(upon start-up, press for an instant the **TARE** key while the instrument version is displayed)
- 2) Enter in the configuration menu of the calibration, in other words **SEtuP >> ConFiG>> CALib.** and press **ENTER**.
- 3) Execute the equalisation (only in case of more digital cells / channels connected to the scale), like described in section 3.3.5.
- 4) Select the calibration menu, in other words **CALib.** and press **ENTER**;
- 5) Set the number of calibration decimals: select the **dECiM.** step and press **ENTER**, with the ▼ ▲ keys move the decimal point in the desired position and press **ENTER**.  
(!) 100
- 6) Set the unit of measure: select the **u.M.** step and press **ENTER**, with the ▼ ▲ keys select the unit of measure: grams (- g -), kilograms (- kg -), tons (- t -) or pounds (- lb -) and press **ENTER**.  
(!) kg
- 7) Select the number of calibration range select the **rAn.nuM** step and press **ENTER**; if there is only one measuring range, select 1 and confirm with **ENTER**; with various fields (up to 3), the type of functioning will be requested (the display shows in sequence the message RANGE.T): select "M.Range" (if a multirange scale) or "M.Divis" (if a multidivisional scale) and confirm with **ENTER**.
- 8) Set the division of the scale or the division of the first range: select the **diV. 1** step and press **ENTER**, with the ▼ ▲ keys select the value (1, 2, 5, 10, 20, 50, 100, 200) and press **ENTER**.  
(!) 1
- 9) Set the capacity of the scale or the first range: select the **CAP.1** step and press **ENTER**, set the value (minimum 100 maximum 999999) and press **ENTER**.  
**TAKE NOTE:** enter the whole value including the decimal digits; for example if the capacity should be over 6 kg and the division 0.001kg (= 1 g), set 6000, or if the capacity should be 1500 kg and the division 0.5 kg, set 15000.  
(!) 100  
  
**NOTE: if the range number set in step 9) is equal to 1, pass directly to point 16)**
- 10) Set the division of the second range: select step **diV. 2** and press **ENTER**, with the ▼ ▲ keys select the value (1, 2, 5, 10, 20, 50, 100, 200) and press **ENTER**.  
(!) 1
- 11) Set the second range: select step **CAP.2** and press **ENTER**, set the value (minimum 100 maximum 999999) and press **ENTER**.  
  
**NOTE: if the range number set in step 9) is equal to 2, pass directly to point 16)**
- 12) Set the division of the third range: select step **diV. 3** and press **ENTER**, with the ▼ ▲ keys select the value (1, 2, 5, 10, 20, 50, 100, 200) and press **ENTER**.  
(!) 1
- 13) Set the third range: select step **CAP.2** and press **ENTER**, set the value (minimum 100 maximum 999999) and press **ENTER**.
- 14) Carry out the acquisition of the calibration points: select the **CALib.P** step and press **ENTER**.  
The instrument will request the following in this order:

Number of signal linearization points: the "CALIBRATION POINTS" message will appear followed by " 1 "; enter the value (from 1 to 8 points, besides ZERO) and press **ENTER**.

ZERO point: the message "UNLOAD THE SCALE AND PRESS ENTER" appears; unload the scale and press **ENTER**.

First linearization point: "Point 1" message will appear followed by the request to enter the value of the calibration weight; enter the value with the numeric keyboard and press **ENTER**. It will be requested to put the calibration weight on the scale (display LCD) and to press **ENTER**.

Following calibration points: as the above.

- 15) if various scales need to be calibrated, press the **C** key twice until the display show "SEL.SCA", select the following scale to be calibrated and repeat all the operations from point 4).

If, on the other hand, the calibration is finished, press various times the **C** key until the instrument asks for saving and confirming with **ENTER**.

**3.4.2 LINEARIZATION POINTS**

By entering in the **SEtuP >> ConFiG >> CALib >> PointS** step it's possible to access a menu which allows to view/modify the linearization points of the last calibration made:

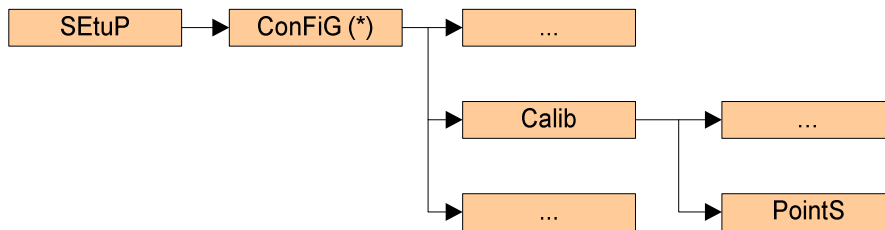

POINT	ADC.POINT	WEIGHT
0	72461	0.00
ACT.1	182567	1.00

POINT	ADC.POINT	WEIGHT
1	182567	1.00
ACT.2	279939	1.89

...		
...		
...		

POINT	ADC.POINT	WEIGHT
7	XXXXXX	XXXX.XX
ACT.8	XXXXXX	XXXX.XX

**KEYS' FUNCTIONS**

- ▲ scrolls forward the points inside the menu;
- ▼ scrolls backward the points inside the menu;
- ◀▶ scroll between the converter points or the millivolt indication and the weight indication;
- 2ndF changes between the converter points' indication and the millivolt indication;
- F1 enters a linearization point;
- F2 cancels a linearization point;
- F3 waits for weight stability and enters a linearization point copying both the converter points / millivolt and

	weight indications;
<b>F4</b>	waits for weight stability and enters a linearization point copying the converter points / millivolt indication;
<b>F5</b>	enters a linearization point copying the converter points / millivolt indication without waiting for weight stability;
<b>ENTER</b>	modifies a point (weight, converter point, millivolt); while entering it confirm the entered values.
<b>C</b>	exits the programming; one is asked to save (the display shows "SurE?"): with <b>ENTER</b> one confirms, with another key one exits without saving. While entering a code, it quickly zeros the present value.

### 3.4.3 ZONE OF USE DIFFERENT THAN THE ZONE OF CALIBRATION

If the zone of use is different than the calibration zone, one should:

- 1) Enter in the Set-up of the instrument;  
(upon start-up, press for an instant the **TARE** key while the instrument version is displayed)
- 2) Enter in the configuration menu of the metric parameters, in other words, **SEtuP >> ConFiG** and press **ENTER**.
- 3) Set the calibration zone: enter in the **GrAV** step and set the gravitational acceleration value of the CALIBRATION ZONE.
- 4) Execute the calibration, following the procedure shown in section 3.3.1.
- 5) Set the zone of use: enter in the **GrAV** step and set the gravity acceleration value of the ZONE OF USE.
- 6) Press various times the **C** key until the instrument asks to save and confirm with **ENTER**.
- 7) The weight error caused by a different gravity attraction value between the zone of calibration and the zone of use is automatically corrected.

### 3.4.4 QUICK ZERO CALIBRATION

Useful for calibrating only the ZERO point when a permanent tare weight is put on a platform (for example a roller unit).

- 1) Enter in the instrument set-up;  
(upon start-up, press for an instant the **TARE/ZERO** key while the instrument version is displayed)
- 2) Enter in the configuration menu of the metric parameters, in other words, **SEtuP >> ConFiG** and press **ENTER**
- 3) Select the **0.CALib** step and press **ENTER**; the message "UNLOAD THE SCALE AND PRESS ENTER" appears.
- 4) Put the preset tare to be cleared on the scale or unload the scale and press **ENTER**.
- 5) Once the calibration has taken place, the scale automatically returns to the **PArAM** step; if one needs to calibrate other scales, press the **C** key, select the next scale to be calibrated and repeat all the operations from point 2.

If, on the other hand, the calibration is done, press various times the **C** key until the instrument asks to save and confirm with **ENTER**.



### 3.4.5 CELL EQUALISATION PROCEDURE

**NOTE:** - this procedure may be selected only if various digital cells / channels are connected to the scale.  
- for this procedure it is advisable to use a weight of at least 1/3 of the capacity.

- 1) Enter in the instrument set-up;  
(upon start-up, press for an instant the **TARE** key while the instrument version is displayed).
- 2) Enter in the configuration menu of the metric parameters, in other words **SEtuP >> ConFiG** and press **ENTER**.
- 3) Enter in the equalisation step: select the **EquAL** step and press **ENTER**. The display shows "SurE?": confirm with **ENTER** in order to reset the previous memorised equalisation and proceed with the **cell equalization**. By pressing the **C** key one can exit the equalisation.
- 4) The message "UNLOAD THE SCALE AND PRESS ENTER" will appear (zero equalization): unload the weighing system and press **ENTER**.
- 5) The message "LOAD CELL 1" will appear (first cell equalization): put a calibration weight on the connected cell and press **ENTER**.
- 6) The message "LOAD CELL 2" will appear (second cell equalization): put **the same calibration weight** on the connected cell and press **ENTER**.
- 7) Repeat the previous operation, if requested, on each connected cell.
- 8) Return to step 6) of section 3.3.1.

**NOTA:** in case of equalisation error, one will be required to repeat the entire procedure.

### 3.4.6 ADJUSTMENT OF EQUALIZATION COEFFICIENT

It's possible to adjust the equalization coefficients in order to correct a possible weight error.

- 1) Select the **SEtuP >> ConFiG >> Adj.CEL** step and press **ENTER**;
- 2) One will be requested to execute the new equalisation ("SURE?"). Press **ENTER** to confirm or **C** to exit.
- 3) With the **F8** and **F9** keys choose the cell for which one wants to correct the coefficient: the LCD display shows the cell number and the selected coefficient, next to it; on the other hand, the display shows the total weight on the scale.
- 4) Put one calibration weight on the connected scale;
- 5) With the **F6** and **F7** keys it's possible to increase / decrease the suggested coefficient; the weight in the LCD display will be modified consequently;
- 6) Return to step 3) to modify another cell coefficient.

At the end of all the operations:

- a) Press **ENTER** to exit and save all the changes (the LCD display will show the "EXIT & SAVE?" message: press **ENTER** to exit and confirm the changes; press **C** to stay in this step); or:
- b) Press **C** to cancel all the changes (the LCD display will show the "EXIT & ABORT?" message: press **ENTER** to exit and cancel all the changes; press **C** to stay in this step).

### 3.4.7 SETTING THE COMMUNICATION WITH DIGITAL CELLS

**Premise:** Only load cells of the same model and the same capacity can compose two digital platforms.

In the case in which one chooses a digital cell type in the **CELtyP** step, the following operations are required:

- 1) Check the correct matching of the ComAuX to the COM3 in the step **SEtuP >> SEriAL >> PortS**;
- 2) Enter in the **CEL.TYP** step and select the type of cells used and the number of digital cells / analogue channels connected.  
The selection of a digital load cell type sets the correct communication parameters with the cells (see **SEtuP >> SEriAL >> CoM.AuX** step. Moreover **ProtoC** must be set as **nonE** ).

**NOTE:** The next step will be shown only if the digital cell type allows it. Otherwise, every digital cell connected to the indicator must be set previously with a 485 increasing address, different from the one of all the other cells.

- 3) In case of DGX conversion card selected as load cell type, it will be required to select the functioning MODE.
- 4) Select "Multicells mode" in order to enable the conversion into digital of each single analogue load cell connected to all the DGX cards.
- 5) It will be possible to enter the number of DGX cards that are used to convert the total load cells forming ALL THE SCALES. **NOTE:** with DGX8 conversion boxes one has to consider 2 cards for each used conversion box (for example with 2 DGX8, set 4 DGX cards).
- 6) The display shows **CEL.Add**: press enter to access setting the 485 address of each load cell / DGX.
- 7) The first address is proposed, confirm with ENTER and **enter the first cell / DGX card serial number**.  
The last entered serial number is proposed for that address.  
In the case of DGX conversion card selected as load cell type, after the serial number confirmation it will be possible to enter the number of load cells connected to that conversion card.  
Press **ENTER** to choose the next address and repeat the operations, or **C** to exit the step.
- 8) Once all the connected cells have been assigned the message "-END-" will appear; by pressing the **C** key it will be required to send the configuration; confirm with enter or **C** to cancel.

The indicator informs with an acoustic signal and the text "Error" if:

- a. The remote scale is enabled in the CoM.AuX (see the **SEtuP >> SEriAL >> rEM.SCA** step);
- b. The **SEtuP >> SEriAL >> rEAdEr** step is set as **CoM.AuX**;
- c. One tries to enter an address with a value greater than the cell number set in the **CELtyP** step;
- d. The serial number is wrong or not corresponding to the ones of the connected cells;
- e. The entered serial number is the same of the one of a cell already connected to the indicator with another 485 code. Correct the serial numbers till all of them are confirmed with "- oK -".
- f. The serial number is correct but:
  - The type of cell set is wrong (see the **CELtyP** step);
  - The assignment of the indicator ports is wrong (see the **SEtuP >> SEriAL >> PortS** step);
  - The cell communication parameters are wrong (moreover **ProtoC** must be set as **none**, see **SEtuP >> SEriAL >> CoM.AuX**);
  - There are some problems with the physical connection of the cells (expecially check the terminal connections and the cell power supply);
- g. The number of total load cell or the number of the load cell connected to a DGX is wrong.

In case of error, the display shows the "rEtry?" message and it's possible to press **ENTER** in order to repeat the operation; otherwise, press **C** to exit the step.

- 9) Return to step 6) of section 3.3.1.

### 3.4.8 THEORETICAL CALIBRATION

**Premise:** it's possible to use this procedure if one does not have a sample weight available for carrying out a real calibration.

- 1) Follow the steps described in section 3.3.1 up to point 13;
- 2) Select the **SEtuP >> ConFiG >> thEo.CA** step and press **ENTER**;
- 3) It will be requested if proceed with the new calibration ("SurE?"). Press **ENTER** to confirm, or **C** to cancel.
- 4) Set the cell capacity  
Enter the cell capacity (the unit of measure is the one configured for the scale: minimum value scale capacity, maximum value 999999) and confirm with **ENTER**.
- 5) **In case of analogue cells:**  
Set the cell sensitivity in mV/V :  
Enter the cell sensitivity in mV/V (max 99.99999 mV/V) and confirm with **ENTER**.  
In case of various connected cells through the junction box, enter the average of the value; in case of dependent channels, enter the sum of the value.  
**In case of digital cells:**  
Set the cell points at the full range capacity :  
Enter the full range capacity digital value (see the load cell datasheet: minimum value is double the scale capacity, maximum value 9999999) and confirm with **ENTER**.

At the end of the calibration, the display shows the message "CALIBRATION EXECUTED" and automatically exits the step, applying the new calibration.

## 4. DISPLAY OF THE GEOGRAPHICAL UTILISATION AND CORRECTION ZONE OF THE WEIGHING ERROR DUE TO THE DIFFERENT GRAVITATIONAL ATTRACTION BETWEEN THE CALIBRATION AND UTILISATION ZONE

### 4.1 INDICATION AND/OR DISPLAY OF THE GEOGRAPHICAL UTILISATION ZONE (compulsory for the legal type instruments)

This instrument conforms to the laws currently in force regarding non-automatic weighing instruments.

Such g-sensitive instruments are influenced by the gravitational acceleration value "g" of the utilisation zone hence it is compulsory to indicate, with a label or on the display, the coded name of the utilisation zone where the weighing machine can be used.

The approved instrument displays, upon start-up, the "g" value relative to the gravitational zone of use for a few seconds, after the name and the installed software version.

### 4.2 CORRECTION OF THE WEIGHING ERROR INTRODUCED BY A DIFFERENT GRAVITATIONAL ATTRACTION VALUE BETWEEN THE CALIBRATION AND UTILIZATION ZONE (compulsory for the legal type instruments)

This instrument conforms to the laws currently in force regarding non-automatic weighing instruments. Such g-sensitive instruments are influenced by the gravitational acceleration value "g" of the utilisation zone so a special programme has been created to compensate for any differences in the gravitational attraction between the place where the weighing machine is calibrated and the place of utilisation.

During configuration the "g" values relative to the utilisation zone and to the zone of calibration are entered at a certain programming step which eliminates the weight error introduced by the different gravitational attraction value.

The approved instrument displays, upon start-up, the "g" value relative to the gravitational zone of use for a few seconds, after the name and the installed software version.

## 5. SERIAL OUTPUTS

The indicator is fitted with three serial ports, both having the output in ASCII code compatible with a wide range of printers, remote displays, PCs and other devices; in the SET-UP ENVIRONMENT one is allowed to match these ports with any available configuration (“ComPC”, “ComPrn” and “ComAux”), in order to satisfy the most varied applications.

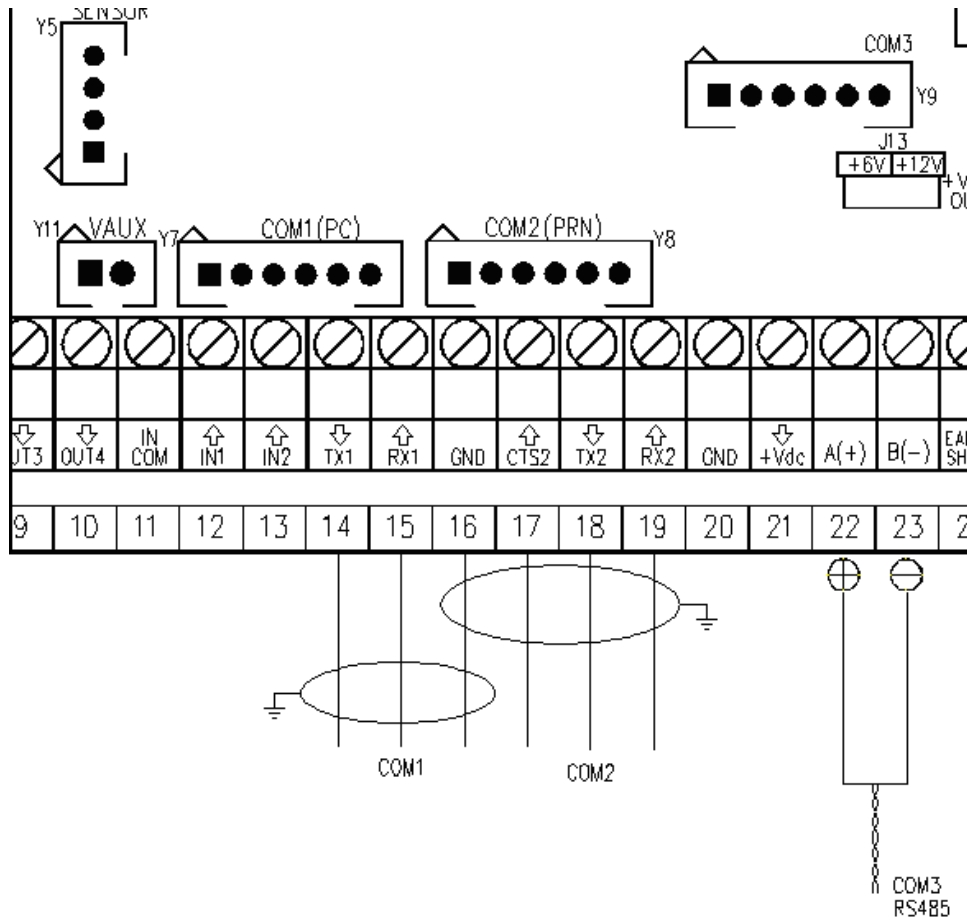

Signal	AMP Connector		Terminal board		
	COM1/COM3 (RS232)	COM2 (RS232)	COM1 (RS232)	COM2 (RS232)	COM3 (RS485)
TX	1	1	14	18	22 A(+)
RX	2	2	15	19	23 B(-)
GND	6	6	16	16	-
CTS	2	3	15	17	-

By the step **SEtuP >> SEriAL >> PortS** it is possible select the function of the serial ports:

Parameter	COM 1	COM 2	COM 3
PC.Pr.AX (!)	ComPC	ComPrn	ComAux
PC.AX.Pr	ComPC	ComAux	ComPrn
Pr.PC.AX	ComPrn	ComPC	ComAux
Pr.AX.PC	ComPrn	ComAux	ComPC
AX.PC.Pr	ComAux	ComPC	ComPrn
AX.Pr.PC	ComAux	ComPrn	ComPC

ComPC: data transmission/reception to PC/PLC, printer, repeater.

ComPrn: data transmission to printer, repeater.

ComAux: data transmission/reception to printer, repeater, remote scale, barcode reader, digital cells.

**!! IMPORTANT !!**

**THE CONNECTION AND THE SOFTWARE CONFIGURATION OF THE SERIAL PORTS MUST BE MADE BY TECHNICAL PERSONNEL WHO KNOWS THE PROCEDURES ON THE BASIS OF THE USER'S NEEDS.**

The data transmission cable must be kept away from the AC power supply lines.

**!! REMOVE VOLTAGE BEFORE OPENING THE INSTRUMENT !!**

**THE STANDARD CONFIGURATION OF THE SERIAL PORTS IS THE FOLLOWING:**

Baud rate = 9600, Parity = None, Data word = 8, Stop bit = 1, CTS signal = No Cts. The configuration may be modified in the SET-UP environment in the << **SERIAL** >> step.

**5.1 RS 485 CONNECTION****IMPORTANT:**

- **Respect the electrical precautionary measures indicated in section 1.**
- **In the case of digital load cells connection read carefully and apply what is described in chapter 2.2**

Below is the RS485 connection of the indicator in the CoM3:

Meaning	Indicator Serial line
TX+/RX+	22 A(+)
TX-/RX-	23 B(-)

On the same RS 485 line it's possible to connect up to 32 devices, among indicators, digital load cells, DGX conversion cards or 485/232 signal converter.

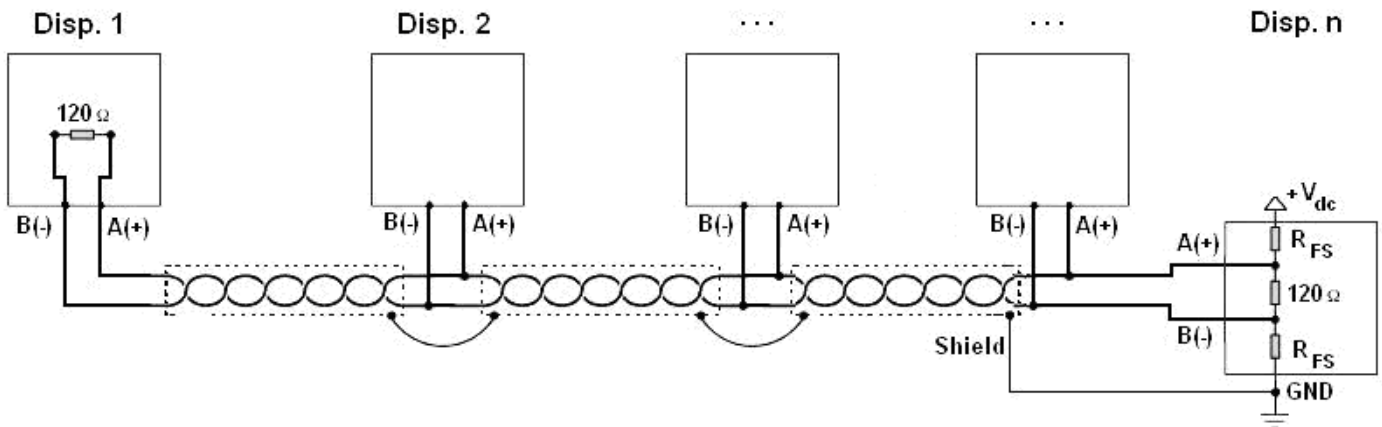

Figure 1: electrical diagram of RS485 connections.

- Use a **STP** (Shielded Twisted Pair) cable in order to make the connection (twisted and shielded pair/s with single shielding for each pair through aluminium band and total shielding through external sheathing).
- The maximum reachable length from the line with the use of the appropriate cable for RS 485 connections, the twisted 2x24 AWG duplex cable, shielded with external sheathing + aluminium band, is of about 1200 meters (see section 1.1.3)
- With very long cables, the cable capacity (normally near 50pF/m) starts being a dominant factor in the power consumption and increases with the increase of speed.

This implies that **the maximum distance can not be covered with the maximum possible speed**. For an approximate value, one can consult the following table:

Baud rate	Total capacity of the cable (pF)
1200	400000
2400	200000
4800	100000
9600	50000
19200	25000
38400	12000
57600	8000
115200	4000

As a general rule, if one has any doubts, it is always preferable to **choose the cable with a greater section**.

- Verify that the grounding satisfies the requirements of section 1.2. Especially, all the digital masses, as well as the analogue masses, and the power circuits, must be connected to the grounding bar and this last one must be connected to the grounding pole.
- The shielding can be connected into a single point of the entire network (as shown in Figure 1) or both its ends, however it's important that **all the masses have the same potential**, in order to avoid the forming of current rings.
- On the RS485 network normally one connects 2 **termination resistances** equal to the characteristic impedance of the cable (typically 120 Ω, see Figure 1), **ONLY** on the 2 devices **which are at the 2 ends of the ring connection** (for example indicator and last device). The terminal resistance is not supplied with the ports of the indicator.
- The difference of potential between the A(+) and B(-) terminals in rest conditions (for example with instrument in set-up phase), **must be of at least 0,2 V**.  
To create a resistive divider which maintains this difference of potential also when all the transmitters are disabled, inert in the RS485 port of the indicator where there are the termination resistances, the **polarisation** or **fail-safe resistences** ( $R_{FS}$  in Figure 1). The value of these resistances is between 390 Ω and 2,2 kΩ.

NOTE: in particular, the value of each of these resistances must be greater than the value calculable through the formula:

$$R_{FS} = \frac{R_{eq}}{2} \times \left( \frac{V_{dc}}{0,2} - 1 \right)$$

in which:

- $V_{dc}$  is the power supply voltage of the line
- $R_{eq}$  is the overall resistance to the A(+) a B(-) heads, supplied by the parallel of the 2 termination resistances and all the input resistances of the devices connected to the bus.

FOR EXAMPLE:

Presuming that a connection has 120 Ω as termination resistance and 32 connected devices, each having an input impedance of 12 kΩ. The  $V_{dc}$  power supply is 5 V.

One calculates  $R_{eq}$ , equal to about 52 Ω, and  $R_{FS}$  which must be at least equal to 624 Ω.

- The connection between the indicator and the digital load cells is made with RS485 protocol in the COM3 configured as CoMAuX**. The indicator can be connected with up to 16 digital load cells.
- It's possible to connect the indicator to digital load cells with 485 4-wire protocol through 422/232 converter. In this case one is required to connect the double TX of RS422 cable to TX+ and TX- converter's pins and the double RX of RS422 cable to RX+ and RX- converter's pins
- In case of connection with non Dini Argeo devices, there may be different ways of line marking: generally one presumes that the A/B indication corresponds to the +/- and HI/LO markings, but this is not always true. Therefore, if the device does not function, one should try inverting the connections even if everything seems to be correct.

- For the correct functioning of the digital load cells, one should, in any case respect all the rules given in the relative specific manuals.

## 5.2 PC CONNECTION

### 9 PIN CONNECTOR

INDICATOR	9 pin Collector	Color
TX	2	Pink
RX	3	Tellow
GND	5	Grey

### RJ45 CONNECTOR

INDICATOR (RJ45 connector)	9 pin Collector	Color
TX 6	2	Orange
RX 3	3	Blue/White
GND 5	5	Green/White

## 5.3 PRINTER CONNECTION

INDICATOR	WTY280 /SMT80 9pin (female)	TMU295 /LX300 25pin (female)	LP542 Plus /TTP243/SMTPLUS 9pin (female)	Standard cable
TX	3	3	3	Pink
CTS	4	20	8	Brown
GND	7	7	5	Grey

INDICATOR	TPR	STANDARD CABLE
GND	GND	Black
CTS	CTS	Yellow
TX	RX	Grey

TPR printer power supply		
	STANDARD CABLE	Terminal box
+VP e +VC	Red and Orange	5 Vaux
GND e GND	Black and Black	16 GND

## 5.4 TRANSMISSION PROTOCOLS

### STANDARD

[available in ComPc, ComPrn, ComAux]

The weight data transmission on the serial port happens in the following format:

**[CC]HH,KK,PPPPPPPP,UM<CR LF>**

In which: **[CC]** = instrument code, es.00 (only with RS485 protocol)

**HH** = UL Underload  
 OL Overload  
 ST Weight stability  
 US Weight instability

, Comma character

**KK** = NT Net Weight  
 GS Gross Weight

, Comma character

**PPPPPPPP** = Weight (8 digits including the possible sign and decimal point).

, Comma character

**UM** = Unit of measure (Kg, g, t, lb)

**<CR LF>** Carriage Return + Line Feed  
 (ASCII Characters 13 and 10)

### AF STRING

[available in ComPc]

The weight data transmission on the serial port happens in the following format:

**[CC]SS,B,LLLLLLLLLLUM,YYTTTTTTTTTUM<CR LF>**

in which: **[CC]** = instrument code, es.00 (only with RS485 protocol)

**SS** UL Underload  
 OL Overload  
 ST Weight stability  
 US Weight instability

, Comma character

**B** Scale Number

, Comma character

**LLLLLLLLLL** Gross weight (10 digits including the possible sign and decimal point).

**UM** = Unit of measure (Kg, g, t, lb)

, Comma character

**YY** 2 spaces if the tare is automatic  
 PT if a tare is pre-set or set manually

**TTTTTTTTTT** Tare weight (10 digits including the possible sign and decimal point).

**UM** = Unit of measure (Kg, g, t, lb)

**<CR LF>** Carriage Return + Line Feed  
 (ASCII Characters 13 and 10)





riP. b

[available in ComPc]

The transmission of the weight data on the serial port takes place in the following format:

**\$FPPPPP <CR>**

in which: \$ = Carattere ASCII decimale 36 (ASCII esadecimale 24H).

F = 0 with stable weight;  
1 with instable weight;  
3 with negative weight, in underload or in overload.

PPPPP = Net Weight on 5 digits, without sign or decimal point.

<CR> = ASCII decimal character 13 (hexadecimal character 0DH).

**NOTE:** the string is valid for all the available transmission modes described in section 5.5.

**NOTE:** The recommended communication protocol for **b** type data transmission include **Baud rate = 4800, Parity = Even, Word = 7, Stop bit = 2.**

“PRINT”

[disponibile per ComPrn]

The weight data transmission on the serial port depends on the print functions of the indicator.

For further details see section 7 “PROGRAMMING THE PRINTOUTS” and section 14 “PRINTOUTS” **USER MAN.REF.**

riPEdC

[disponibile per ComAuX]

In this case one can configure up to three weight repeaters so that each one displays different information.

Selecting the “riPEdC” protocol it’s possible to configure:

- the “dSP1” repeater having 01 address so that it receives the weight from scale 1;
- the “dSP2” repeater having 02 address so that it receives the weight from scale 2;
- the “dSPSum” repeater having 03 address so that it receives the sum weight.

For each of them it’s possible to choose if:

- NO disable entry of data;
- ONLY IF SELECTED send data only if the corresponding scale is selected on the display of the indicator;
- ALWAYS send data independently from the selected scale on the display of the indicator.

**5.5 TRANSMISSION MODES**

Data transmission from PC Serial Port can be done in 5 different ways:

TRANSMISSION ON REQUEST

[available in ComPC]

It requires an external command from the PC to send the data requested. Transmission can take place at any time requested.

CONTINUOUS TRANSMISSION

[available in ComPC, ComPrn, ComAux]

- ComPC: Continuous transmission of the standard string (**ProtoC = StAnd** step), or of the extended AF0X string (**ProtoC = AF0X** step) or continuous transmission of the personalised string.  
This mode is used for interfacing with computers, remote displays and other devices that require a constant update of data regardless of weight stability (10 transmissions per second with Baud rate at 9600 and stable weight).
- ComPrn: L’indicatore trasmette in continuo i dati configurati nel formato di stampa 01.  
In alternativa, impostando il solo blocco “300” nel formato di stampa 01, è possibile trasmettere la STRINGA STANDARD (o la STRINGA TIPO AF0X, se configurata per la porta PC.).  
Per dettagli sulla configurazione dei formati di stampa vedere paragrafo 7.
- ComAux: La trasmissione dei dati di peso su porta seriale avviene col protocollo STANDARD.



INPUT WEIGH

[available in ComPC]

Transmission is automatic each time the input weigh is made.

**INbbYYYbbbbXXXXXXXXXXUM<CR LF>**

in which:	bb =	Space characters ASCII Characters 32
	YYY =	Axles total number
	bbbb =	Space characters ASCII Characters 32
	XXXXXXXXXX =	Weight (10 digits including the possible sign and decimal point)
	UM =	Unit of measure (Kg, g, t, lb)
	<CR LF>	Carriage Return + Line Feed ASCII Characters 13 and 10

OUTPUT WEIGH

[available in ComPC]

Transmission is automatic each time the output weigh is made.

**OUTbYYYbbbbXXXXXXXXXXUM<CR LF>**

in which:	b =	Space characters ASCII Characters 32
	YYY =	Axles total number
	bbbb =	Space characters ASCII Characters 32
	XXXXXXXXXX =	Weight (10 digits including the possible sign and decimal point)
	UM =	Unit of measure (Kg, g, t, lb)
	<CR LF>	Carriage Return + Line Feed ASCII Characters 13 and 10

TRANSMISSION AT THE END OF THE WEIGHING CYCLE

[available in ComPC]

The transmission takes place automatically each time that an input/output weighing cycle or a single weigh is carried out; the transmitted string corresponds to the one of the "LAST" command (see following paragraph).

## 5.6 SERIAL COMMANDS FORMAT

<b>LEGEND</b>	
<b>[CC] o &lt;II&gt;</b>	instrument code, e.g. 00 (only with RS485 protocol)
<b>&lt;CR LF&gt;</b>	Carriage Return + Line Feed (ASCII characters 13 and 10)
<b>&lt;ESC&gt;</b>	ASCII character ASCII 27
<b>&lt;STX&gt;</b>	ASCII character ASCII 02
<b>b</b>	space character, ASCII 32.

<b><u>SERIAL ERRORS</u></b>	
Upon each serial command received the instrument transmits a string containing the answer (see the command description) or it transmits one of the following indications:	
<b>OK&lt;CR LF&gt;</b>	it is shown when a correct command is transmitted from the PC to the indicator. The OK answer does not imply that the instrument executes the zero.
<b>ERR01&lt;CR LF&gt;</b>	it is shown when a correct command is transmitted from the PC to the indicator however it is followed by letters inserted involuntarily (I.E.: READF, TARES...).
<b>ERR02&lt;CR LF&gt;</b>	it is shown when a correct command is transmitted from the PC to the indicator, but containing wrong data.
<b>ERR03&lt;CR LF&gt;</b>	it is shown when a non allowed command is transmitted. It may be a command not used in the selected functioning mode or the command reaches the indicator in the instant in which the keyboard buffer is already occupied by another command
<b>ERR04&lt;CR LF&gt;</b>	it is shown when an inexistent command is transmitted.
<b>NOTE:</b> The instrument doesn't transmit any indication with the short commands, like the ones made up of only one letter and then the possible parameter.	

### COMMANDS

#### Version reading:

Instrument's answer:  
in which:

**[CC]VER<CR LF>**  
**[CC]VER,vvv,E-AF03b<CR LF>**  
vvv is the firmware version

#### Data reading:

Instrument's answer:

**[CC]READ<CR LF>** or: **[CC]R<CR LF>**  
see section 5.4.

#### Preset tare:

in which:

**[CC]TMANTTTTT<CR LF>** or: **[CC]WTTTTTT<CR LF>** (short command)  
W= command  
TTTTTT = tare in ASCII, max 6 characters  
Example: W10.0 <CR LF>

#### Zero:

**[CC]ZERO<CR LF>** or: **[CC]Z<CR LF>**

#### Clear:

**[CC]CLEAR<CR LF>** or: **[CC]C<CR LF>**

#### Reading of extended weight string:

Instrument's answer:

**[CC]B,hh,NNNNNNNNNN,YYTTTTTTTTTT,PPPPPPPPPP,MMMMMMMMMM,uu<CR LF>**

in which: [CC] = INSTRUMENT CODE IN THE FORMAT OF TWO ASCII DECIMAL DIGITS  
ONLY WHEN THE 485 PROTOCOL IS SELECTED (FOR EXAMPLE 00)  
hh = UL Underload

	OL	Overload
	ST	Stability of the display
	US	Instability of the display
B =		scale number (zero for the remote scale)
NNNNNNNNNN		net weight on 10 characters including sign and decimal point
YY =		"PT" if the tare weight is entered with the keyboard, otherwise YY = " " (two space characters) if the tare weight is weighed
TTTTTTTTTT		tare weight on 10 characters including sign and decimal point
PPPPPPPPPP		always 0
MMMMMMMMMM		always 0
uu =		Unit of measure "Kg" "bg" "bt" "lb
CR =		Carriage Return (ascii character decimal code 13)
LF =		Line Feed (ascii character decimal code 10)

**NOTE:** With **remote scale** in error only with AF0X or ALIBI protocol in the place of the UL/OL/ST/US heading flags it will put ER; this is valid for all the weight reading commands which contain the status flags; for example: READ /R /RALL /REXT.

#### Temporary view of message on the display: [CC]DISPNNVVVVV<CR LF>

in which: NN: display number of the indicator, (00 for 3590E LED display / CPWE weight section, 01 for 3590E LCD display / CPWE data section)  
V: character to be displayed (at least 1, cut off at the number of characters which may be viewed by the indicated display)

The message remains for the time configured through the DINT command; if one selects to view the message permanently on a display and one wants to cancel the operation, transmit the DISPNN command without any message: the display, specified in the command (NN) goes back to view the usual information relative to the selected functioning mode.

#### Setting a display viewing interval: [CC]DINTXXNNNN<CR LF>

in which: XX: code which identifies the display (00 for 3590E LED display / CPWE weight section, 01 for 3590E LCD display / CPWE data section)  
NNNN: visualisation interval (in milliseconds), N is an ASCII hex character; for example, to set a visualisation time of 2 seconds (therefore 2000 milliseconds), which converted into hex become 07D0, the command becomes DINT0007D0<CR><LF>.

By setting NNNN = 0000, the transmitted message with the DISP command (see above) remains permanently viewed on the selected display.

#### **With approved instrument**

- For the display 00 (00 for 3590E LED display / CPWE weight section), the maximum settable time is 5 seconds (5000 milliseconds, HEX 1388).
- One should wait for the end of an eventual current visualisation before viewing a following one.

#### Data of last weigh made [CC]LAST<CR LF>

Instrument's answer:

**If tare set = 0:**

<I/O>, <Progressive>, <ID>, <IN Weight>, <OUT weight>, <IN-OUT difference>

**If single weigh:**

<I/O>, <Progressive>, <ID>, <Weight>, <Set Tare>, <Net>

in which:

<I/O> = I  
O

Input weigh  
Output weigh

< Progressive >

Progressive number of 6 digits which increases with each pressing of **F6** or **F7**.

<ID> = weigh ID

<IN weight>	Input weight.
<OUT weight>	Output weight.
<IN-OUT difference>	Difference between <IN weight> and <OUT weight>
<Weight>	Weight (in input or in output).
<Set tare>	Set tare weight
<Net>	Difference between <Weight> and <Set Tare>.

**NOTES:**

- The indicator's answer is updated with each input, output or single weigh.
- If the "b tYPE" protocol has been set, the answer to the command becomes the one described in the protocol itself (see following paragraph); furthermore, the answer of the indicator is updated every input/output weighing cycle or single weigh.

**Reading of converter points relative to the weight: [CC]RAZF<CR LF>**

Instrument's answer: [CC]SS,RZ,RRRRRRRRRR,vv<CR LF>  
 In which: SS UL Underload  
 OL Overload  
 ST Stability of the weight  
 US Instability of the weight  
 RRRRRRRRRR Value of converter points (10 characters)

**Reading of microvolts relative to the weight: [CC]MVOL<CR LF>**

Instrument's answer: [CC]SS,VL,MMMMMMMMMM,uv<CR LF>  
 In which: SS UL Underload  
 OL Overload  
 ST Stability of the weight  
 US Instability of the weight  
 MMMMMMMMMM Value of microvolts (10 characters)

**Reading of net weight with sensitivity times 10: [CC]GR10<CR LF>**

Instrument's answer: [CC]SS,GX,VVVVVVVVV,UM<CR LF>  
 In which: SS UL Underload  
 OL Overload  
 ST Stability of the weight  
 US Instability of the weight  
 GX Weighing times 10 status  
 VVVVVVVVV Value of net weight times 10 (10 characters)  
 UM Unit of measure (Kg, g, t, lb)

**NOTE:** The instrument does not transmit the OK answer to the short commands (R, T, Z, P....).

**Modification of GR10 command response: [CC]GR10X<CR LF>**

in which: GR10= command  
 X→ E enabled  
 X→ D disabled  
 Example: GR10E<CR LF>

If enabled, it modifies the format of the GR10 command response string: it responds to the GR10 command with the number of the active scale in the place of the "GX – weighing status x 10" ).

The setting is valid when the indicator is turned off. To save it permanently in the instrument one should transmit the command in the set-up status.

**Setpoint command:****[CC]STPTnFxxxxxOyyyyyy<CR LF>**

in which:

n, expressed in hexadecimal, indicates the number of SETPOINTS (1, 2, 3, 8, 9, A, B, C, D, E, F).

**F** : the following weight value indicates the DISABLING of the relays (OFF).**O** : the following weight value indicates the ENABLING of the relays (ON).

xxxxxx e yyyyyy take on the enabling or disabling setpoint value: the digits must be entered WITHOUT decimal point, omitting the NON significant zeros.

**Example in case of instrument with 10,000 kg capacity and 1 g division:**Command : **STPT1F5000O6500** (Disabling of first relay at 5 kg and enabling at 6,5 kg)Answer: **OK****NOTE:** Negative answer in the following conditions:

- one of the two entered values surpasses the capacity.
- one of the two entered values has a minimum division which is incongruent with the one set in the instrument.
- the disabling value surpasses the enabling one.

**Reading of the instrument serial number:****[CC]SN<CRLF>**

Instrument's answer: SN: XXXXXXXX

In which:

XXXXXX

Serial Number (can be more that 6 digits)

**Reading of the board information:****[CC]BOARD<CRLF>**

Instrument's answer: LOADER: 203, BOARD ID: 1, BOARD REV: 1, HWCFG: 65535, SN: 2769492, BOARD NAME: KDM06

In which:

aaa

loader version in hex form (e.i. 203 for loader 2.03)

bbb

board ID (numeric value)

ccc

board revision (numeric value)

ddd

hardware config (numeric value)

xxx

serial number

nnn

board name (up to 8 characters)

**AFX type string reading and scale information:****[CC]RALL<CR LF>**

Instrument's answer:

[AFX string] B,NNNNNNNUM,LLLLLLLUM,SSS,AAA,CCC,TTT,XXXXX-YYYYYY&lt;CR LF&gt;

In which:

B Number of platform on which the totalisation has been made.

NNNNNNNUM Last net weight totalized with unit of measure.

LLLLLLLUM Last gross weight totalized with unit of measure.

SSS Scale status: 000 start-up

001 weighing

002 selection of functioning mode

003 generic menu

004 set-up menu

005 user menu

006 exit from set-up

007 Update Firmware status

008 setting of user default

009 setting of technical default

010 switch channel

011 setting of technical default

012 Test of the PC serial ports

013 Test of the PRN serial ports

AAA Counter of pressed keys.

CCC Code of last key pressed.

TTT Counter of totalisations.

XXXXX Last rewriting number stored in the Alibi memory.

YYYYYY Last weigh number stored in the Alibi memory.



**Bridge data between serial port:** [CC]BRIDGEX<CRLF>  
 BRIDGE=command  
 X→1 = COMPC→COMPRN  
 X→2 = COMPC→COMAUX  
 EXAMPLE: BRIDGE1

Instrument's answer: [CC]OK<CR LF>

This serial command allows to create a bridge from the pc port to another. After 10 seconds of silence the instrument goes back to the state before sending the command.

In the bridge state between the serial, the instrument shows "BRIDGE" on the LED display, and the bridge serial ports on the LCD display (ex. "COM1 <-> COM2").

## 5.7 ADVANCED COMMANDS

### **[GKBB] Reading of the data in the keyboard buffer:**

This following command allows for **the reading of the data in the keyboard buffer (max 20 keys)** (only if the transmission of the pressed keys code is disabled):

#### Syntax

Format	<ESC><II>GKBB<STX>
Parameters	-
Answer	- <ESC><II>OK<STX> if the buffer is empty - If the buffer is not empty, two hexadecimal characters for each key, in the order in which these have been pressed, from left to right.
Example	<ESC>01GKBB<STX>
Result	If for example, with empty keyboard buffer, the 1, 2, 3, 4, 5, 6 keys have been pressed, the instrument answer will be the following: <ESC>0B0C0D0E0F10<STX>

**NOTE:** the reading of the keyboard buffer causes the cancellation.

### **[EKBB] Cancellation of the data inside in the keyboard buffer:**

With this command it is possible to **cancel the contents of the keyboard buffer** (only in the case in which the transmission of the pressed keys' code is disabled):

#### Syntax

Format	<ESC><II>EKBB<STX>
Parameters	-
Answer	<ESC><II>OK<STX>
Example	<ESC>01EKBB<STX>
Result	Cancellation of the keyboard buffer

### **[OUTP] Enabling/disabling of the relay output:**

#### Syntax

Format	<ESC><II> OUTPNVVVV <STX> or <ESC><II> OUTPNNVVVV <STX>
Parameters	- N = output number (expressed in hexadecimal) - 0 to enable simultaneously all the outputs - from 1 to 4 to identify the single output of the motherboard from 8 to F to identify the same output (only up to OUT11) of the expansion board - NN= output number (expressed in hexadecimal) - 00 to enable simultaneously all the outputs - from 01 to 0 to identify the single output of the motherboard and from 08 to 0F to identify the single output (up to OUT11) of the expansion board

	<ul style="list-style-type: none"> <li>- 10 to enable the 12 output (OUT12) of the expansion board.</li> <li>- VVVV = enabling/disabling code;</li> <li>- for the single output, V = 0000 disabled, while V = 0001 enabled.</li> <li>- all the outputs (in other words, N = 0), the value identifies the outputs to be enabled (expressed in hexadecimals);</li> </ul>
<b>Response</b>	<ESC><II>OK<STX> The response does not imply that the command has been made.
<b>Example</b>	<ESC>01OUTP00412<STX> or <ESC>01OUTP000412<STX>
<b>Result</b>	Configuration of the outputs (see below the suggested explanation)

A bit is ascribed to each relay:

Expansion board outputs (optional)												Motherboard outputs			
OUT 16	OUT 15	OUT 14	OUT 13	OUT 12	OUT 11	OUT 10	OUT 9	OUT 8	OUT 7	OUT 6	OUT 5	OUT 4	OUT 3	OUT 2	OUT 1
Bit 15	Bit 14	Bit 13	Bit 12	Bit 11	Bit 10	Bit 9	Bit 8	Bit 7	Bit 6	Bit 5	Bit 4	Bit 3	Bit 2	Bit 1	Bit 0

The bit at 1 is interpreted as active output, while the bit at 0 as disabled relay.

If, for example, one wants to enable the **OUT5**, **OUT11** outputs of the Expansion board and **OUT2** relay of the Motherboard relays, the binary combination will be:

Expansion board outputs (optional)												Motherboard outputs			
OUT 16	OUT 15	OUT 14	OUT 13	OUT 12	OUT 11	OUT 10	OUT 9	OUT 8	OUT 7	OUT 6	OUT 5	OUT 4	OUT 3	OUT 2	OUT 1
Bit 15	Bit 14	Bit 13	Bit 12	Bit 11	Bit 10	Bit 9	Bit 8	Bit 7	Bit 6	Bit 5	Bit 4	Bit 3	Bit 2	Bit 1	Bit 0
0	0	0	0	0	1	0	0	0	0	0	1	0	0	1	0

Which, in hexadecimals, corresponds to the number 0412; therefore the command will be OUTP00412 + CR + LF or OUTP000412 + CR + LF.

#### NOTES:

- The set point enabling command does not work neither in the set-up environment nor in the weighing phase; if the output function is different than "nonE". (SEtuP >> outPut >> r.CONF. step, rLFunC parameter).

**[INPU] Optoisolated input reading****Syntax**

<b>Format</b>	<ESC><II>INPU<N><STX>
<b>Parameters</b>	N = input number (expressed in hexadecimal): - 0 to simultaneously read all the inputs. - from 1 to 2 to identify the single input of the Motherboard and from 3 to 8 to identify the single input of the Expansion board.
<b>Answer</b>	<ESC><II>INPUNVVVV <STX> N = input number (expressed in hexadecimal), described previously VVVV = input \ inputs status: - for the single input, V = 0000 means input not active, while V = 0001 active input - for all the inputs (in other words N = 0), the returned value corresponds to the hexadecimal codification of the status of the inputs
<b>Example</b>	<ESC>01INPU0 <STX>
<b>Result</b>	Reading of indicator's inputs' status (see the following explanation).

A bit is ascribed to each input:

<u>Not managed bits</u>								Expansion board inputs (optional)						Motherboard inputs	
Bit 15	Bit 14	Bit 13	Bit 12	Bit 11	Bit 10	Bit 9	Bit 8	in.8	in.7	in.6	in.5	in.4	in.3	in. 2	in. 1
Bit 15	Bit 14	Bit 13	Bit 12	Bit 11	Bit 10	Bit 9	Bit 8	Bit 7	Bit 6	Bit 5	Bit 4	Bit 3	Bit 2	Bit 1	Bit 0

Therefore if the INPU00026 string is received, the hexadecimal value, converted into binary, indicates that the status of the inputs is the following:

<u>Not managed bits</u>								Expansion board inputs (optional)						Motherboard inputs	
Bit 15	Bit 14	Bit 13	Bit 12	Bit 11	Bit 10	Bit 9	Bit 8	in.8	in.7	in.6	in.5	in.4	in.3	in. 2	in. 1
0	0	0	0	0	0	0	0	0	0	1	0	0	1	1	0

The active inputs are therefore **in.6**, **in.3** of the Expansion board and **in.2** of the motherboard

**NOTES:**

- With the bits 8 to 15, no input is assigned, and are fixed at zero
- The reading command of the inputs works also in the set-up environment

**[INUN] Request of a numeric value entry on the 3590E LED display / CPWE weight section:****Syntax**

<b>Format</b>	<ESC><II>INUN<X><M>,<H>,<I>,<L>,<D>,<P><STX>
<b>Parameters</b>	X = numeric or alphanumeric character (0 – 9 ; A – Z ; a – z) displayable in the digit on the extreme left of the 3590E LED display / CPWE weight section (not modifiable); M = minimum enterable value in decimals (0 ≤ M ≤ H) H = maximum enterable value in decimals (0 ≤ H ≤ 999'999'999'999'999'999, 18 digits). I = value displayed initially in decimals, substituted then by the entered one (M ≤ I ≤ H); if the entered value is less than the enterable

	<p>minimum value (M), the minimum value will initially be displayed (M).  L = maximum number of enterable characters in decimals  ( 0 ≤ L ≤ 18)  D = number of decimal digits (in decimals)  P = initial position in decimals of the blinking digit (in other words the position of the first value to be modified).  - if P = 0, the blinking digit is the least significant one  - if P = 1, the blinking digit is the most significant one</p>
Answer	<ESC><II>OK<STX>
Example	<ESC>01INUNt,0,10000,0,5,3,0<STX>
Result	The t <u>00.000</u> message appears on the 3590E LED display / CPWE weight section with the least significant digit blinking (underlined), while waiting for the entry of a numeric value

If the entered value is greater or less respectively to the maximum or minimum set value, the instrument will emit an error sound signal.

### [INUA] Request of a numeric value entry on the 3590E LCD display / CPWE data section:

#### Syntax

Format	<ESC><II>INUA<CC><LL><I><STX>
Parameters	<p>CC = decimal position from which the entry of the numeric data starts, from left to right.  LL = number of characters in decimals which make up the numeric data to be entered  I = selection/unselection of the display of an initial value, previously entered in the user buffer (using the WUBU command described later on):  - I = 0 not displayed  - I = 1 displayed</p>
Answer	<ESC><II>OK<STX>
Example	<ESC>01INUA08071<STX>
Result	If <u>preceded</u> by the <ESC>01WUBU1234567<STX> command, it causes the 1234567 message to be shown on the 3590E LCD display / CPWE data section, with the character 1 blinking, starting from the position 08 of the 3590E LCD display / CPWE data section (in other words the digit 8). At this point it is possible to set 8 numerical digits which will substitute the displayed ones.

**NOTE:** If an alphanumeric string is in the buffer, a number of blank spaces corresponding to the number of digits set in LL will be shown on the display, starting from the set cursor position.

### [IALA] Request of alphanumeric text entry on the 3590E LCD display / CPWE data section:

#### Syntax

Format	<ESC><II>IALA<CC><LL><I><STX>
Parameters	<p>CC = decimal position from which the entry of the numeric data starts, from left to right.  LL = number of characters in decimals which make up the numeric data to be entered  I = selection/unselection of the display of an initial value, previously entered in the user buffer (using the WUBU command described later on):  - I = 0 not displayed</p>

	<b>- I = 1 displayed</b>
<b>Answer</b>	<ESC><II>OK<STX>
<b>Example</b>	<ESC>01IALA08071<STX>
<b>Result</b>	If <u>preceded</u> by the <ESC>01WUBUABCDEFG<STX> command, it causes the ABCDEFG message to be shown on the 3590E LCD display / CPWE data section, with the character 1 blinking, starting from the position 08 of the 3590E LCD display / CPWE data section (in other words the digit 8). At this point it is possible to set 8 numerical digits which will substitute the displayed ones.

When exiting the entry phase, the displayed data is frozen on the 3590E LCD display / CPWE data section and it remains until a new serial command does not switch the visualisations (for example a DISP command or a new visualisation entered with the INUA or IALA commands, previously described).

The turning off causes the restoration of the standard weight data.

### [GINR] Reading of entered data:

GINR + CR + LF

### Syntax

<b>Format</b>	<ESC><II>GINR<STX>
<b>Parameters</b>	-
<b>Answer</b>	Entry of value on the 3590E LED display / CPWE weight section case: <ul style="list-style-type: none"> <li>- - 1 if one exits from the entry phase with the C key;</li> <li>- Entered value in decimals and confirmed with ENTER;</li> </ul> Entry of value on 3590E LCD display / CPWE data section case: <ul style="list-style-type: none"> <li>- 2 if one exits from the entry phase with the C key;</li> <li>- 1 if the value has been entered and confirmed with ENTER</li> </ul> To read the entered string, use the <ESC>RUBU<STX> command described later on
<b>Example</b>	<ESC> 01GINR<STX>
<b>Result</b>	Reading of the user buffer and transmission of the data read on the PC

### Reading and writing of the user buffer:

**Premise:** the user buffer is the memory area in which the temporary storage of entered data is used (using the indicator keyboard) by the user or made visible by the user.

The previous request commands on the display of data entry, taking advantage of this buffer.

### [WUBU] Reading of the user buffer:

### Syntax

<b>Format</b>	<ESC><II>WUBU<AAA...A><STX>
<b>Parameters</b>	AAA...A is the numeric and/or alphanumeric string (UP TO 32 characters) which are entered in the user buffer
<b>Answer</b>	<ESC><II>OK<STX>
<b>Example</b>	<ESC>01WUBU<ABCDE><STX>
<b>Result</b>	The ABCDE string is stored in the user buffer

**IMPORTANT:** do not modify the user buffer while the instrument is waiting for the data entry: this operation can cause system malfunctioning, which are eliminated only when the instrument is turned off.

**[RUBU] Reading of the user buffer:****Syntax**

<b>Format</b>	<ESC><II>RUBU<STX>
<b>Parameters</b>	-
<b>Answer</b>	<ESC><II>AAA...A <STX> In which AAA...A is the numeric and/or alphanumeric string (UP TO 32 Characters), read in the user buffer. If the number of characters is less than 32, blank spaces will be added in order to complete the 32 transmitted characters.
<b>Example</b>	<ESC>01RUBU<STX>
<b>Result</b>	<ESC>01STRING <STX>

**[TOPR] Transmission of numeric and/or alphanumeric string to printer:****Syntax**

<b>Format</b>	<ESC><II>TOPR<XXX...X> <STX>
<b>Parameters</b>	XXX...X = numeric and/or alphanumeric string which one wants to print
<b>Answer</b>	<ESC><II>OK<STX> The answer does not imply that the command has been made.
<b>Example</b>	<ESC>01TOPRABCDE<STX>
<b>Result</b>	The ABCDE string will be printed

**TECHNICAL NOTE:** The reception and transmission buffers of the indicator are of 256 bytes; knowing that each transmitted character is equal to one byte, the maximum number of characters which can be transmitted is 248. This value changes depending on the transmitted data.

**NOTES:**

- It is possible to print numeric and alphanumeric characters ( A...Z, a...z, 0...9), for example TOPRABCabc123 + CR + LF
- It is possible to print ASCII characters by entering the corresponding decimal code (on three digits) preceded by the \ character; for example, if one wants to print the message <!!ATTENTION!!>, the command will be the following: TOPR\060\033\033ATTENTION\033\033\062+ CR + LF;
- It is possible to print the print blocks by entering the block number preceded by the \M abbreviation; for example, if one wants to print the block 301 NET WEIGHT (see section 7.3 LIST OF PRINT BLOCKS), 302 GROSS WEIGHT, 303 TARE, the command will be the following: TOPR\M301\M302\M303 + CR + LF
- The command is not enabled if the instrument is approved.

**[OIN] Key with which one has exit from the user input**

With this command it is possible to know which key the user used to exit the input (ENTER or C).

**Syntax**

<b>Format</b>	<ESC><II>OIN<STX>
<b>Parameters</b>	-
<b>Answer</b>	<ESC><II>OIN[<KEY>   NO]<STX>
<b>Key</b>	ENT Exited with the Enter key CLR Exited with the Clear key
<b>Example</b>	<ESC>01OIN<STX>
<b>Result</b>	<ESC>01OINENT<STX>

If the command is wrong one will have the <ESC><II>OINNO<STX> message.

**Simulation of key pressing:****[CC]KEYPXX<CR LF>**

in which XX is the code of the pressed key:

CODE	PRESSED KEY
00	F1 key
01	F2 key
02	F3 key
03	F4 key
04	F5 key
05	F6 key
06	F7 key
07	F8 key
08	F9 key
09	F10 key
0A	'0' numeric key
0B	'1' numeric key
0C	'2' numeric key
0D	'3' numeric key
0E	'4' numeric key
0F	'5' numeric key
10	'6' numeric key
11	'7' numeric key
12	'8' numeric key
13	'9' numeric key
14	(.) point key
15	ZERO key
16	ENTER/Fn key
17	2ndF key
18	C key

Response of the instrument: OK&lt;CR LF&gt;: command accepted

If the simulated key has two linked functions (key pressed briefly or at length, like the TARE key), if the KEYP command is followed by the key release command (KEYR) within a maximum time of 1,5 seconds, the simple function will be executed (key pressed briefly); otherwise the second function will be executed (key pressed at length).

**Key release simulation****[CC]KEYR<CR LF>**

Response: [CC]OK&lt;CR LF&gt;

**LEGEND**

[CC]= instrument code, e.g.. 00 (only with RS485 protocol).

&lt;CR LF&gt;= Carriage Return + Line Feed (ASCII characters 13 and 10).

**Selecting / Deselecting an element of the database:****[CC]SREC,X,NNNN<CR LF>**

Instrument's answer :

[CC]SREC,X,NNNN,EE&lt;CR LF&gt;

In which:

X database index:

0 customer database

1 material database

3 vehicle database

NNNN Position Number to select in the database  
( 9999 to deselect the element )

EE OK in case of executed command

KO in case of command not executed

**Read selected position in database:****[CC]GREC,X<CR LF>**

Instrument's answer: [CC]GREC,X,PPPP<CR LF>  
 In which: X database index:  
           0 customer database  
           1 material database  
           2 input text database  
           3 vehicle database  
 PPPP Position number selected in the database  
 ( NULL if no position has been selected)

**Reading of compiled positions and total number of positions in the database:****[CC]NREC,X<CR LF>**

Instrument's answer: [CC]NREC,X,CCCC,TTTT<CR LF>  
 In which: X database index:  
           0 customer database  
           1 material database  
           2 input text database  
           3 vehicle database  
 CCCC Number of compiled positions in the database  
 TTTT Total number of available positions in the database

**5.8 CUSTOMISATION OF THE STRING [available in ComPC e ComPrn]****Personalise string configuration on the ComPC:**

The instrument is able to transmit in a continuous manner or as a response to the READ command on the port linked with ComPC a data string configurable in the 100 print format through Dinitools™. To restore the transmission of the instrument strings, one should configure only block "300".

**NOTE:** format #100 contains up to 50 macros.

**Personalise string configuration on the ComPrn:**

The instrument is able to transmit in a continuous manner on the port linked with ComPrn a string of data configurable in the 01 print format.

For further details in regards to configuring the print formats through Dinitools™ see the relative manual.



## 6. NETWORK MANAGEMENT

If in the indicator there is an ethernet board (SETHNET) it is possible to create a network between two or more instruments. If there are only two indicators the connection is made through a crossed Ethernet cable, while for the connection of more than two instruments it is necessary to use a switch/access point. In this last case, if there is an existing access point or cabled network, it is necessary to configure the network parameters of the modules before connecting them (see following section).

All the SETHNET have this predefined address: 192.168.16.205.

### 6.1 INSTRUMENT NETWORK CONFIGURATION

So that the instruments can communicate through the SETHNET modules, it is necessary to configure the following parameters:

- BAUD RATE of the COM.AUX a 115200 (step **SEtuP** >> **SEriAL** >> **CoM.AuX** >> **bAud** >> **115200**)
  - Enable the ETHERNET protocol on the COM.AUX ( step **SEtuP** >> **SEriAL** >> **CoM.AuX** >> **ProtoC** >> **Eth.nEt**).
- This protocol require the configuration of the following parameters:

1. **nodE.Gr** NODE GROUP
2. **nodE.id** NODE ID
3. **iP.ModE** TYPE OF IP (STATIC or DYNAMIC)
4. **iP.Addr** IP ADDRESS
5. **nEt.MSK** SUBNET MASK
6. **Auto.db** AUTOMATIC DB ALIGNEMENT (If enabled, it enables the automatic synchronization of the databases)
7. **n.nAME** NETWORK NAME

Example: network between two instruments with static address.

#### EXAMPLE 1

##### GROUP 1

##### ID 1

**IP ADDRESS** 192 . 168 . 16 . 2  
**SUBNET MASK** 255 . 255 . 255 . 0

##### GROUP 1

##### ID 2

**IP ADDRESS** 192 . 168 . 16 . 7  
**SUBNET MASK** 255 . 255 . 255 . 0

#### EXAMPLE 2

##### GROUP 2

##### ID 1

**IP ADDRESS** 192 . 168 . 35 . 2  
**SUBNET MASK** 255 . 255 . 255 . 0

##### GROUP 2

##### ID 2

**IP ADDRESS** 192 . 168 . 35 . 7  
**SUBNET MASK** 255 . 255 . 255 . 0

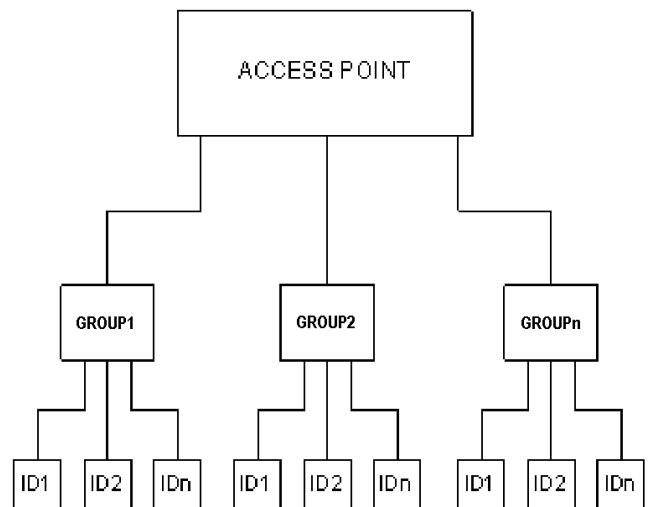

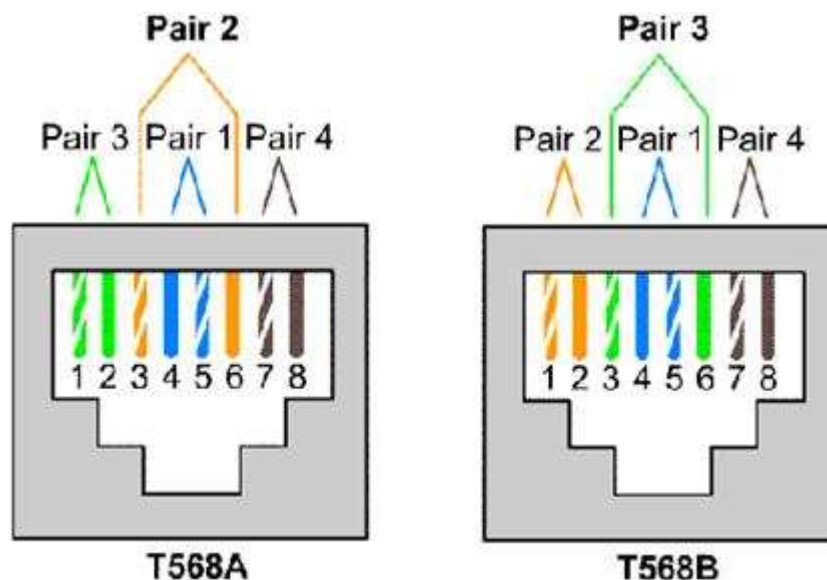
**568A**

pin 1 = White/green  
 pin 2 = Green  
 pin 3 = White/orange  
 pin 4 = Blue  
 pin 5 = White/blue  
 pin 6 = Orange  
 pin 7 = White/brown  
 pin 8 = Brown

**568B**

pin 1 = White/orange  
 pin 2 = Orange  
 pin 3 = White/green  
 pin 4 = Blue  
 pin 5 = White/blue  
 pin 6 = Green  
 pin 7 = White/brown  
 pin 8 = Brown

**6.2 NETWORK FUNCTIONS**

Through the network it is possible to:

- print and share the databases/data among the various instruments. By inserting an article on an indicator, this will be brought to all the indicators which have the automatic enabling of the articles;
- see the input weighs and the same article data from all the indicators in the network;
- through this function in **SEtuP >> SEriAL >> rEM.SCA >> EnAb**. the remote scale function in the indicator is enabled, which acts as a repeater without a connected scale, and in the following step **SET REMOTE ID**, one enters the number of the **IDs** (up to 4) of which this last one will act as a remote scale.

## 7. ANALOGUE OUTPUT (OPTIONAL)

Through an optional interface, it is possible to use an analogue output a 16 bit configurable at 0 – 10V, 0 – 20 mA or 4 – 20 mA.

The voltage and the output current from the interface are proportional to the gross weight or net weight present on the scale. In regards to the electrical connection scheme, see section 8.

### 7.1 OPERATING MODES

#### 7.1.1 OUTPUT ON THE GROSS WEIGHT

The value of the analogue output grows proportionally to the gross weight on the scale in relation to the configured value for the gross weight at 0 (AO ZE), and the one configured for the gross weight equal to the capacity (AO MA).

When the gross weight is equal or greater than the capacity, the output takes on the value set for AO MA, while in the underload condition (gross weight  $\leq$  -100d with approved instrument) the output takes on the value set for AO MI.

Trend examples (approved instrument)

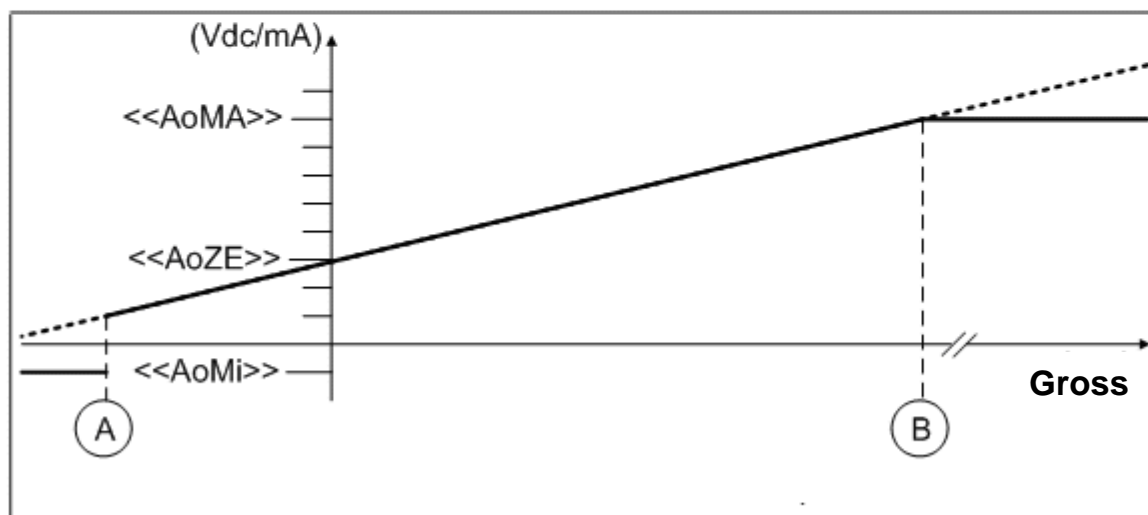
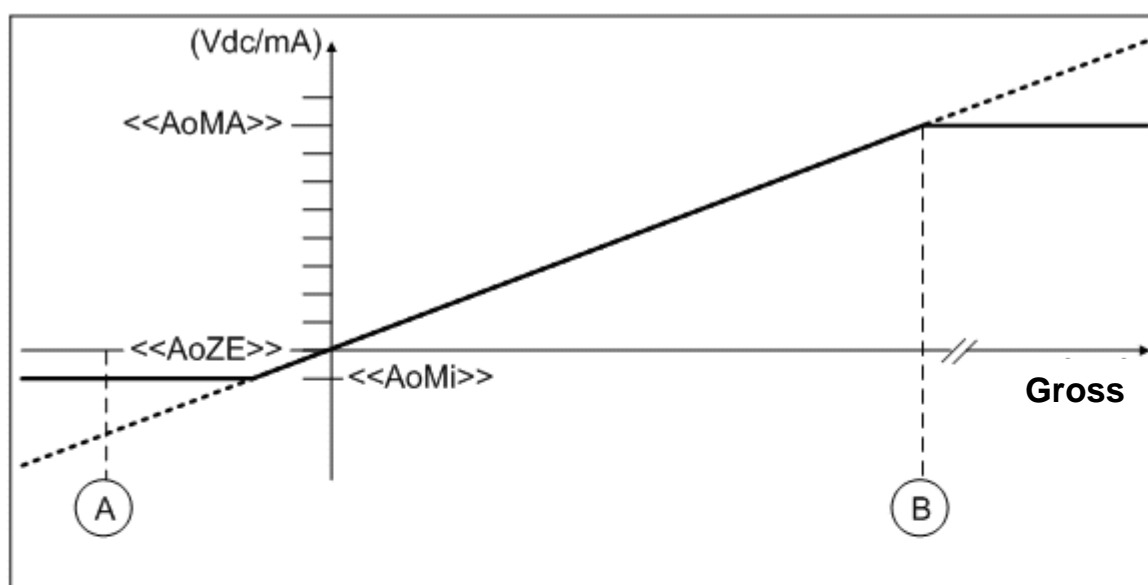

(A) Gross = -100d

(B) Gross =Max. Scale Capacity

### 7.1.2 OUTPUT ON THE NET WEIGHT

The value of the analogue output grows proportionally to the net weight on the scale in relation to the value configured for the net weight at 0 (AO ZE), and the one configured for the net weight equal to the capacity (AO MA).

When the gross weight is equal or greater than the capacity + 9e, the output takes on the value set for AO MA, while in the underload condition (gross weight  $\leq -100d$  with approved instrument) the output takes on the value set for AO MI.

#### Trend examples (approved instrument)

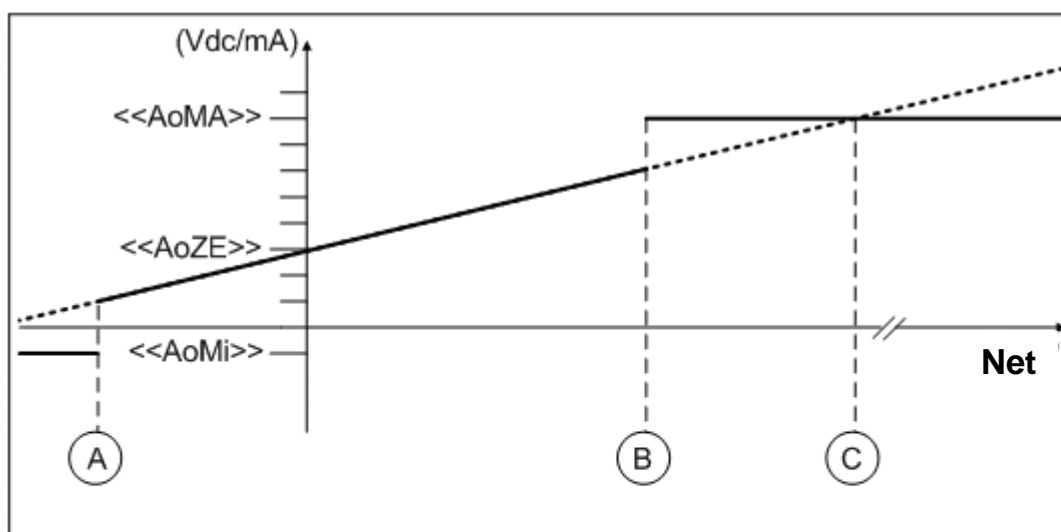
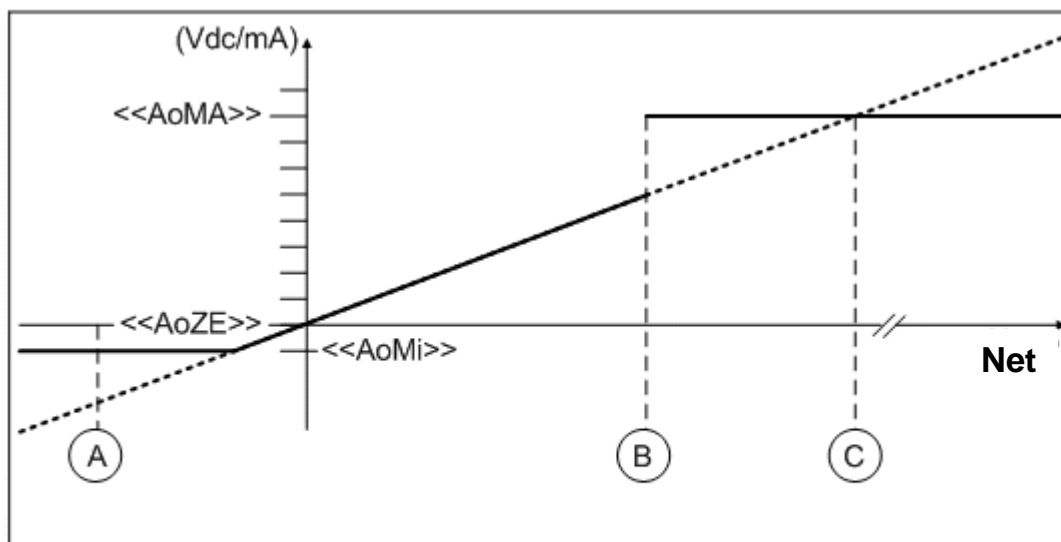

- (A) Gross = -100d
- (B) Gross = Max. Scale Capacity + 9e
- (C) Net = Max. Scale Capacity

## 7.2 CONFIGURATION

In order to configure the parameters, one needs to enter the SET-UP environment in the **Anout** step inside the **SEtuP** menu:

If various scales are connected (see the **nuM.SCA** parameter), the number of the scale to be configured, will be requested; the configurations within this menu must be carried out for each connected scale.

### **SLot** SLOT SELECTION

One selects the SLOT to be used with the analogue output: SLOT 1 or SLOT2; it is possible to indifferently use either SLOT.

### **ModE** OPERATING MODE

AO G = analogue output on gross weight

AO n = analogue output on net weight

Once the functioning mode is confirmed, one sets the values of the analogue output useful for the calculation in the weighing phase, of the value that the output must take on proportionally; in other words, the digital/analogue converter values are entered (between 0 and 65535) to which corresponds a certain output value in voltage or in current. In this configuration the instrument keys take on the following meanings (functions):

**ENTER** By pressing once after a value is entered, it activates the corresponding output analogue value, (allowing the check) but the step still remains inside in case of a new modification. By pressing a second time (on the same entered value) it confirms and exits the step.

**C** Allows to quickly zero the present value.

**NUMERICAL KEYS** Allow entering values, from right to left.

### **AoMA** MAXIMUM VALUE

By entering this step, one sets the maximum value of the analogue output, in other words the corresponding value of the full scale capacity. This value can be anywhere between 0 and 65535 (values of the digital/analogue converter); if a higher digit is entered, the instrument emits a prolonged sound, after which it zeros the value just entered.

### **AoZE** SCALE ZERO VALUE

By entering this step, one sets the analogue output value when the scale displays zero weight. This value can be anywhere between 0 and 65535 (values of the digital/analogue converter); if a higher digit is entered, the instrument emits a prolonged sound, after which it zeros the value just entered.

### **AoMi** MINIMUM VALUE

By entering this step, one sets the minimum value of the analogue output. This value can be anywhere between 0 and 65535 (values of the digital/analogue converter); if a higher digit is entered, the instrument emits a prolonged sound, after which it zeros the value just entered.

### **APPROXIMATE VALUES BETWEEN THE D/A CONVERTER AND ANALOGUE OUTPUT**

D/A CONVERTER VALUES	VOLTAGE VALUE (V)	CURRENT VALUE (mA)
1070	0	
1375		0
11500		4
52010		20
62450	10	

## 8. PROGRAMMING THE PRINTOUTS

It is possible to programme 30 different formats to be linked to 11 print functions:

- "S.F.01" function >> print key
- "S.F.02" function >> partial total
- "S.F.03" function >> general total
- ...

For the complete list of the functions and the linking of the formats, see the 14 "PRINTOUTS" section of the **USER MANUAL**.

During the printing, the indicator uses the format linked to that printout.

It is possible to configure the formats:

- **through the Dinitools™ software** for PC, and transmitted to the indicator through the serial line; it is necessary that the print format number ("Print Format Number") is a value between 1 and 30 to indicate the format to be overwritten. Once the formats are configured one should carry out the linkages of the interested functions (**USER MAN.REF.**).
- **manually from the indicator** by entering in the **SEtuP >> SEriAL >> Prn.FMt** step inside the SET-UP environment.

### MANUAL CONFIGURATION OF THE PRINT FORMATS

Each format is made up of a maximum of 2048 memory storages (only the first 1000 are manually modifiable from the indicator), which, when programmed, these will produce the desired printout; in each line one can enter (through a 3-digit code, from 300 onwards) a command named "print block", which will produce a certain type of printout, for example: PRINT NET WEIGHT (code 301), which will print the net weight value, the unit of measure and the CR or CR LF to go to the next line.

Or it is possible to print a single alphanumeric character, entering the relative ASCII code in the line (from 0 to 255).

To configure a print format:

- Enter in the **SEtuP >> SEriAL >> Prn.FMt** parameter.
- The display shows:

**C.F. XX** in which:

**XX** indicates the number of the format to be modified (from 01 to 30)

- Select the print format to be configured using the arrow keys ▲ ▼ and press the **ENTER** key
- Once entered in a format (for example C.F. 01), the display shows:

**XXX.YYY** in which:

**XXX** is number of the line which one is programming.

**YYY** is the entered code (from 0 to 255 the ASCII code is printed, from 300 onwards the relative block is printed).

- Select the line to be programmed using the arrow keys ▲ ▼ and press the **ENTER** key
- The display shows "CHANGE" for an instant and onwards:

**XXX** in which:

**XXX** is the value to be modified.

- Enter a value and press the **ENTER** key to confirm; the **C** key clears the entered value and if pressed again it cancels the operation.
- If a print block with parameters from 600 onwards has been entered, after having pressed the **ENTER** key the displays shows:

**XXX** in which:

**XXX** is the value to be modified.

- Enter a valid value and press the **ENTER** key to confirm.
- Once programmed all the desired lines one should enter in the last line block 300 (PRINT END);
- Press the **C** key to exit; the display will show the saving request; press the **ENTER** key to confirm or another key to cancel.

### KEYS' FUNCTIONS

- ▲ scrolls forward inside the lines of the print format.
- ▼ scrolls backward inside the lines of the print format.
- F1** enters a print block or an ASCII character in the selected line moving the consecutive blocks of one place.
- F2** cancels the current line compacting the blocks that follow.
- F3** enters a print end in the current line.
- ENTER** modifies the code in the current line; while entering it confirms the entered code.
- C** exits the programming; one is asked to save (the display shows "SAVE?"): with **ENTER** one confirms, with another key one exits without saving. While entering a code, it quickly zeros the present value.

### NUMERICAL

- KEYBOARD** allows entering a code inside of the selected printing line.

### NOTES

- For the complete list of the ASCII codes and the print blocks, see the sections "ASCII CODE TABLE" and "LIST OF PRINT BLOCKS".
- To terminate the programming of a format, it is necessary that the last command be "Print end": one should enter the code 300 (or press the **F3** key) in the last line of the format.

### PRINTING ON THE PC SERIAL PORT

By programming correctly a format, it is possible to direct the printing on the PC serial port, and then bring it back onto the printer port; the blocks to be used are:

318 (PRINTING ON PC PORT), 319 (PRINTING ON SERIAL PORT), 320 (FORCES THE PRINTING).

The correct syntax in the format is the following:

- **318 PRINTS ON PC PORT**
- prints block or ASCII character
- ...
- **320 FORCES PRINTING**
- **319 PRINTS ON PRINTER PORT**
- prints block or ASCII character
- ...
- **320 FORCES PRINTING**
- 300 PRINT END

The "Forces print" block executes the transmission of all the blocks or ASCII characters entered BEFORE the same block; reading block 318, the printout is directed onto the PC port..

All the blocks or ASCII characters entered here are instead transmitted through the printer serial port.

## 8.1 PROGRAMMING EXAMPLE

One programmes a format to be linked to a PRINT key function (**S.F.01** function) in this way:

MARIO ROSSI SRL  
Date – time  
Gross weight  
Tare weight  
Net weight  
3 blank lines  
Print end

```

MARIO ROSSI SRL
1/02/2005 – 19:00:00
GROSS          2.000kg
TARE           0.000kg
NET            2.000kg
  
```

After having entered in the SET-UP environment, follow the procedures below:

- 082 (letter “R”) Enter in the **SEtuP >> SEriAL >> Prn.FMt** parameter.
- Select the print format to be configured through the arrow keys ▲ ▼ and press the **ENTER** key.
- Select the line to be programmed through the arrow keys ▲ ▼ and press the **ENTER** key.
- The display shows the first line to be programmed; enter the 077 code (ASCII relative to the letter “M”); confirm with **ENTER**.
- The display shows the following line; enter the 065 code (ASCII relative to the letter “A”); confirm with **ENTER**.
- Repeat the operations by entering the following codes:

073 (letter “I”)  
079 (letter “O”)  
032 (space)  
082 (letter “R”)  
079 (letter “O”)  
083 (letter “S”)  
083 (letter “S”)  
073 (letter “I”)  
013 (terminator CR)  
032 (space)  
013 (terminator CR)  
379 (prints date – time)  
013 (terminator CR)  
032 (space)  
013 (terminator CR)  
302 (prints gross weight)  
013 (terminator CR)  
301 (prints net weight)  
013 (terminator CR)  
303 (prints tare weight)  
013 (terminator CR)  
032 (space)  
013 (terminator CR)  
032 (space)  
013 (terminator CR)  
032 (space)  
013 (terminator CR)  
300 (print end)

**\*\* It is possible to enter the print end also with the F3 key \*\***

- Press the **C** key to exit the programming: the display shows “SAVE?”, confirm with **ENTER** (one goes back into the “SERIAL” parameter).
- Exit the SETUP environment of the instrument by pressing the **C** key various times: the display shows “SAVE?”, confirm the changes made with **ENTER** (the instrument returns to weighing).



## 8.2 ASCII CODE TABLES

## 8.2.1 CODE PAGE 1252 WINDOWS LATIN 1

	00	01	02	03	04	05	06	07	08	09	0A	0B	0C	0D	0E	0F
00	<u>NUL</u> 0000	<u>STX</u> 0001	<u>SOT</u> 0002	<u>ETX</u> 0003	<u>EOT</u> 0004	<u>ENQ</u> 0005	<u>ACK</u> 0006	<u>BEL</u> 0007	<u>BS</u> 0008	<u>HT</u> 0009	<u>LF</u> 000A	<u>VT</u> 000B	<u>FF</u> 000C	<u>CR</u> 000D	<u>SO</u> 000E	<u>SI</u> 000F
10	<u>DLE</u> 0010	<u>DC1</u> 0011	<u>DC2</u> 0012	<u>DC3</u> 0013	<u>DC4</u> 0014	<u>NAK</u> 0015	<u>SYN</u> 0016	<u>ETB</u> 0017	<u>CAN</u> 0018	<u>EM</u> 0019	<u>SUB</u> 001A	<u>ESC</u> 001B	<u>FS</u> 001C	<u>GS</u> 001D	<u>RS</u> 001E	<u>US</u> 001F
20	<u>SP</u> 0020	!	"	#	\$	%	&	'	(	)	*	+	,	-	.	/
30	0	1	2	3	4	5	6	7	8	9	:	;	<	=	>	?
40	@	A	B	C	D	E	F	G	H	I	J	K	L	M	N	O
50	P	Q	R	S	T	U	V	W	X	Y	Z	[	\	]	^	_
60	`	a	b	c	d	e	f	g	h	i	j	k	l	m	n	o
70	p	q	r	s	t	u	v	w	x	y	z	{		}	~	<u>DEL</u> 007F
80	€ 20AC		ƒ 201A	„ 0192	“ 201E	… 2026	† 2020	‡ 2021	ˆ 02C6	% 2030	Š 0160	< 2039	€ 0152		Ž 017D	
90		˘ 2018	˙ 2019	˚ 201C	˛ 201D	• 2022	– 2013	— 2014	˜ 02DC	™ 2122	š 0161	> 203A	œ 0153		ž 017E	ÿ 0178
A0	<u>MBSP</u> 00A0	ı 00A1	ı̇ 00A2	£ 00A3	¤ 00A4	¥ 00A5	ı̇ 00A6	§ 00A7	¨ 00A8	© 00A9	ª 00AA	« 00AB	¬ 00AC	– 00AD	® 00AE	¯ 00AF
B0	° 00B0	± 00B1	² 00B2	³ 00B3	´ 00B4	µ 00B5	¶ 00B6	· 00B7	¸ 00B8	¹ 00B9	º 00BA	» 00BB	¼ 00BC	½ 00BD	¾ 00BE	¿ 00BF
C0	À 00C0	Á 00C1	Â 00C2	Ã 00C3	Ä 00C4	Å 00C5	Æ 00C6	Ç 00C7	È 00C8	É 00C9	Ê 00CA	Ë 00CB	Ì 00CC	Í 00CD	Î 00CE	Ï 00CF
D0	Ð 00D0	Ñ 00D1	Ò 00D2	Ó 00D3	Ô 00D4	Õ 00D5	Ö 00D6	× 00D7	Ø 00D8	Ù 00D9	Ú 00DA	Û 00DB	Ü 00DC	Ý 00DD	Þ 00DE	ß 00DF
E0	à 00E0	á 00E1	â 00E2	ã 00E3	ä 00E4	å 00E5	æ 00E6	ç 00E7	è 00E8	é 00E9	ê 00EA	ë 00EB	ì 00EC	í 00ED	î 00EE	ï 00EF
F0	ø 00F0	ñ 00F1	ò 00F2	ó 00F3	ô 00F4	õ 00F5	ö 00F6	÷ 00F7	ø 00F8	ù 00F9	ú 00FA	û 00FB	ü 00FC	ý 00FD	þ 00FE	ÿ 00FF

## 8.2.2 CODE PAGE 1251 WINDOWS CYRILLIC

	00	01	02	03	04	05	06	07	08	09	0A	0B	0C	0D	0E	0F
<b>00</b>	<u>NUL</u> 0000	<u>STX</u> 0001	<u>SOT</u> 0002	<u>ETX</u> 0003	<u>EOT</u> 0004	<u>ENQ</u> 0005	<u>ACK</u> 0006	<u>BEL</u> 0007	<u>BS</u> 0008	<u>HT</u> 0009	<u>LF</u> 000A	<u>VT</u> 000B	<u>FF</u> 000C	<u>CR</u> 000D	<u>SO</u> 000E	<u>SI</u> 000F
<b>10</b>	<u>DLE</u> 0010	<u>DC1</u> 0011	<u>DC2</u> 0012	<u>DC3</u> 0013	<u>DC4</u> 0014	<u>NAK</u> 0015	<u>SYN</u> 0016	<u>ETB</u> 0017	<u>CAN</u> 0018	<u>EM</u> 0019	<u>SUB</u> 001A	<u>ESC</u> 001B	<u>FS</u> 001C	<u>GS</u> 001D	<u>RS</u> 001E	<u>US</u> 001F
<b>20</b>	<u>SP</u> 0020	<u>!</u> 0021	<u>"</u> 0022	<u>#</u> 0023	<u>\$</u> 0024	<u>%</u> 0025	<u>&amp;</u> 0026	<u>'</u> 0027	<u>(</u> 0028	<u>)</u> 0029	<u>*</u> 002A	<u>+</u> 002B	<u>,</u> 002C	<u>-</u> 002D	<u>.</u> 002E	<u>/</u> 002F
<b>30</b>	<u>0</u> 0030	<u>1</u> 0031	<u>2</u> 0032	<u>3</u> 0033	<u>4</u> 0034	<u>5</u> 0035	<u>6</u> 0036	<u>7</u> 0037	<u>8</u> 0038	<u>9</u> 0039	<u>:</u> 003A	<u>;</u> 003B	<u>&lt;</u> 003C	<u>=</u> 003D	<u>&gt;</u> 003E	<u>?</u> 003F
<b>40</b>	<u>@</u> 0040	<u>A</u> 0041	<u>B</u> 0042	<u>C</u> 0043	<u>D</u> 0044	<u>E</u> 0045	<u>F</u> 0046	<u>G</u> 0047	<u>H</u> 0048	<u>I</u> 0049	<u>J</u> 004A	<u>K</u> 004B	<u>L</u> 004C	<u>M</u> 004D	<u>N</u> 004E	<u>O</u> 004F
<b>50</b>	<u>P</u> 0050	<u>Q</u> 0051	<u>R</u> 0052	<u>S</u> 0053	<u>T</u> 0054	<u>U</u> 0055	<u>V</u> 0056	<u>W</u> 0057	<u>X</u> 0058	<u>Y</u> 0059	<u>Z</u> 005A	<u>[</u> 005B	<u>\</u> 005C	<u>]</u> 005D	<u>^</u> 005E	<u>_</u> 005F
<b>60</b>	<u>`</u> 0060	<u>a</u> 0061	<u>b</u> 0062	<u>c</u> 0063	<u>d</u> 0064	<u>e</u> 0065	<u>f</u> 0066	<u>g</u> 0067	<u>h</u> 0068	<u>i</u> 0069	<u>j</u> 006A	<u>k</u> 006B	<u>l</u> 006C	<u>m</u> 006D	<u>n</u> 006E	<u>o</u> 006F
<b>70</b>	<u>p</u> 0070	<u>q</u> 0071	<u>r</u> 0072	<u>s</u> 0073	<u>t</u> 0074	<u>u</u> 0075	<u>v</u> 0076	<u>w</u> 0077	<u>x</u> 0078	<u>y</u> 0079	<u>z</u> 007A	<u>{</u> 007B	<u> </u> 007C	<u>}</u> 007D	<u>~</u> 007E	<u>DEL</u> 007F
<b>80</b>	<u>Ђ</u> 0402	<u>Ѓ</u> 0403	<u>Ѕ</u> 201A	<u>Ї</u> 0453	<u>Љ</u> 201E	<u>Њ</u> 2026	<u>Ћ</u> 2020	<u>Ќ</u> 2021	<u>Є</u> 20AC	<u>Ѓ</u> 2030	<u>Ѕ</u> 0409	<u>Ї</u> 2039	<u>Љ</u> 040A	<u>Њ</u> 040C	<u>Ћ</u> 040B	<u>Ќ</u> 040F
<b>90</b>	<u>ђ</u> 0452	<u>ѓ</u> 2018	<u>ѕ</u> 2019	<u>ї</u> 201C	<u>љ</u> 201D	<u>њ</u> 2022	<u>ќ</u> 2013	<u>џ</u> 2014	<u>џ</u> 2122	<u>љ</u> 0459	<u>ѕ</u> 203A	<u>ї</u> 045A	<u>љ</u> 045C	<u>њ</u> 045B	<u>ќ</u> 045F	<u>џ</u> 045F
<b>A0</b>	<u>ЊБSP</u> 00A0	<u>Ѓ</u> 040E	<u>Ѕ</u> 045E	<u>Ї</u> 0408	<u>Љ</u> 00A4	<u>Њ</u> 0490	<u>Ћ</u> 00A6	<u>Ќ</u> 00A7	<u>Є</u> 0401	<u>Ѓ</u> 00A9	<u>Ѕ</u> 0404	<u>Ї</u> 00AB	<u>Љ</u> 00AC	<u>Њ</u> 00AD	<u>Ћ</u> 00AE	<u>Ќ</u> 0407
<b>B0</b>	<u>°</u> 00E0	<u>±</u> 00E1	<u>І</u> 0406	<u>і</u> 0456	<u>Ҁ</u> 0491	<u>μ</u> 00E5	<u>¶</u> 00E6	<u>·</u> 00E7	<u>ё</u> 0451	<u>№</u> 2116	<u>е</u> 0454	<u>»</u> 00EB	<u>ј</u> 0458	<u>ѕ</u> 0405	<u>ѕ</u> 0455	<u>ї</u> 0457
<b>C0</b>	<u>А</u> 0410	<u>В</u> 0411	<u>В</u> 0412	<u>Г</u> 0413	<u>Д</u> 0414	<u>Е</u> 0415	<u>Ж</u> 0416	<u>З</u> 0417	<u>И</u> 0418	<u>Й</u> 0419	<u>К</u> 041A	<u>Л</u> 041B	<u>М</u> 041C	<u>Н</u> 041D	<u>О</u> 041E	<u>П</u> 041F
<b>D0</b>	<u>Р</u> 0420	<u>С</u> 0421	<u>Т</u> 0422	<u>У</u> 0423	<u>Ф</u> 0424	<u>Х</u> 0425	<u>Ц</u> 0426	<u>Ч</u> 0427	<u>Ш</u> 0428	<u>Щ</u> 0429	<u>Ъ</u> 042A	<u>Ы</u> 042B	<u>Ь</u> 042C	<u>Э</u> 042D	<u>Ю</u> 042E	<u>Я</u> 042F
<b>E0</b>	<u>а</u> 0430	<u>б</u> 0431	<u>в</u> 0432	<u>г</u> 0433	<u>д</u> 0434	<u>е</u> 0435	<u>ж</u> 0436	<u>з</u> 0437	<u>и</u> 0438	<u>й</u> 0439	<u>к</u> 043A	<u>л</u> 043B	<u>м</u> 043C	<u>н</u> 043D	<u>о</u> 043E	<u>п</u> 043F
<b>F0</b>	<u>р</u> 0440	<u>с</u> 0441	<u>т</u> 0442	<u>у</u> 0443	<u>ф</u> 0444	<u>х</u> 0445	<u>ц</u> 0446	<u>ч</u> 0447	<u>ш</u> 0448	<u>щ</u> 0449	<u>ъ</u> 044A	<u>ы</u> 044B	<u>ь</u> 044C	<u>э</u> 044D	<u>ю</u> 044E	<u>я</u> 044F

## 8.2.3 CODE PAGE 1253 WINDOWS GREEK

	00	01	02	03	04	05	06	07	08	09	0A	0B	0C	0D	0E	0F
<b>00</b>	<u>NUL</u> 0000	<u>STX</u> 0001	<u>SOT</u> 0002	<u>ETX</u> 0003	<u>EOT</u> 0004	<u>ENQ</u> 0005	<u>ACK</u> 0006	<u>BEL</u> 0007	<u>BS</u> 0008	<u>HT</u> 0009	<u>LF</u> 000A	<u>VT</u> 000B	<u>FF</u> 000C	<u>CR</u> 000D	<u>SO</u> 000E	<u>SI</u> 000F
<b>10</b>	<u>DLE</u> 0010	<u>DC1</u> 0011	<u>DC2</u> 0012	<u>DC3</u> 0013	<u>DC4</u> 0014	<u>NAK</u> 0015	<u>SYN</u> 0016	<u>ETB</u> 0017	<u>CAN</u> 0018	<u>EM</u> 0019	<u>SUB</u> 001A	<u>ESC</u> 001B	<u>FS</u> 001C	<u>GS</u> 001D	<u>RS</u> 001E	<u>US</u> 001F
<b>20</b>	<u>SP</u> 0020	!	"	#	\$	%	&	'	(	)	*	+	,	-	.	/
<b>30</b>	0	1	2	3	4	5	6	7	8	9	:	;	<	=	>	?
<b>40</b>	@	A	B	C	D	E	F	G	H	I	J	K	L	M	N	O
<b>50</b>	P	Q	R	S	T	U	V	W	X	Y	Z	[	\	]	^	_
<b>60</b>	`	a	b	c	d	e	f	g	h	i	j	k	l	m	n	o
<b>70</b>	p	q	r	s	t	u	v	w	x	y	z	{		}	~	<u>DEL</u> 007F
<b>80</b>	€ 20AC		ƒ 201A	„ 0192	… 2026	† 2020	‡ 2021		‰ 2030		< 2039					
<b>90</b>		˘ 2018	˙ 2019	˚ 201C	˛ 201D	• 2022	— 2013	— 2014		™ 2122		> 203A				
<b>A0</b>	<u>NBSP</u> 00A0	ˆ 0385	ˆ 0386	£ 00A3	* 00A4	¥ 00A5	ı 00A6	§ 00A7	¨ 00A8	© 00A9		« 00AB	¬ 00AC	— 00AD	® 00AE	— 2015
<b>B0</b>	° 00B0	± 00B1	² 00B2	³ 00B3	´ 0384	µ 00B5	¶ 00B6	· 00B7	ˆ 0388	ˆ 0389	ˆ 038A	» 00BB	ˆ 038C	¼ 00BD	ˆ 038E	ˆ 038F
<b>C0</b>	ı 0390	Α 0391	Β 0392	Γ 0393	Δ 0394	Ε 0395	Ζ 0396	Η 0397	Θ 0398	Ι 0399	Κ 039A	Λ 039B	Μ 039C	Ν 039D	Ξ 039E	Ο 039F
<b>D0</b>	Π 03A0	Ρ 03A1		Σ 03A3	Τ 03A4	Υ 03A5	Φ 03A6	Χ 03A7	Ψ 03A8	Ω 03A9	İ 03AA	ÿ 03AB	ά 03AC	έ 03AD	ή 03AE	ί 03AF
<b>E0</b>	ύ 03B0	α 03B1	β 03B2	γ 03B3	δ 03B4	ε 03B5	ζ 03B6	η 03B7	θ 03B8	ι 03B9	κ 03BA	λ 03BB	μ 03BC	ν 03BD	ξ 03BE	ο 03BF
<b>F0</b>	π 03C0	ρ 03C1	ς 03C2	σ 03C3	τ 03C4	υ 03C5	φ 03C6	χ 03C7	ψ 03C8	ω 03C9	ι 03CA	ύ 03CB	ό 03CC	ύ 03CD	ώ 03CE	

## 8.3 LIST OF PRINT BLOCKS

### LEGEND:

- b** indicates a space character (ASCII 32 decimal character).  
**UM** unit of measure of the active scale (kg, **bg**, **bt**, lb).  
**UMD** unit of measure of the database (kg, **bg**, **bt**, lb).  
**+ T** terminator: depending on the setting of the **SEtuP >> SEriAL >> tErMin** "SET TERMINATOR TYPE" step of the SET-UP environment, a CR or CRLF, LF or no terminator is added.  
**XXX\*** These blocks do not work without the alibi memory (optional).

The weight field expands from right to left, with many spaces (ASCII 32 decimal character) for completing the field length.

### NOTE

- The weight and weighing values expand from from right to left, with the necessary spaces in order to complete the field length.
- The weighing numbers are increased with each input/output weighing cycle or with each single weigh.

### 8.3.1 ORDER BY KIND

#### CODE

#### PRINT FORMAT

GENERIC	
300	PRINT END
307	DOTTED LINE ----- + T
308	PRINTS 3 CRLF
309	DATE / TIME FOR DP24/DP190 <b>bHH:MMbDD/MM/YY + T</b>
318	PRINTS ON PC PORT
319	PRINTS ON PRINTER PORT
320	FORCES PRINTOUT
366	DATE DD/MM/YY + T
367	TIME HH:MM + T
368	DATE TIME DD/MM/YY <b>bHH:MM + T</b>
369	FOLLOWING MACRO TERMINATOR SKIPS
372	HEADING 1 XXXXXXXXXXXXXXXXXXXXXXXXXXXX in which XXXXXXXXXXXXXXXXXXXX are the 24 characters of the first line of the heading; just the entered characters are printed, from left to right.
373	HEADING 2 XXXXXXXXXXXXXXXXXXXXXXXXXXXX
374	HEADING 3 XXXXXXXXXXXXXXXXXXXXXXXXXXXX
377	PRINTS TERMINATOR CR or CRLF or NO TERMINATOR
378	PRINTS A SPACE <b>b</b>
379	SCALE UNIT OF MEASURE UM
380	DATABASE UNIT OF MEASURE UM
392	PRINTS WEIGH ID ID <b>b:XXX + T</b> In which XXX is the weigh number, from 1 to 999; only the entered characters are printed, expanding from left to right.
410	JUST WEIGHT ID VALUE In which XXX is the weigh number, from 1 to 999; only the entered characters are printed, expanding from left to right. XXX
421	STANDARD KD PROTOCOL STRING
422	AF0X PROTOCOL STRING Through the blocks 421 and 422 it is possible to print the STANDARD or AFXX serial string (see section 5.4 TRANSMISSION PROTOCOLS for the description); the terminator of the string depends on the setting of the <b>SEtuP &gt;&gt; SEriAL &gt;&gt;tErMin</b> step of the SET-UP environment (CR or CRLF or no terminator).
423	PRINTS TERMINATOR CR or CRLF or NO TERMINATOR
424	RELEASES PAPER FOR TM295

425	ACTIVATES PAPER PRESENT SENSOR FOR TM295	
426	ACTIVATES TIMEOUT FOR TM295	
427	END PAGE UPSIDE DOWN FOR TM295	
	This command causes the ticket to be expelled in the insertion area.	
463	CANCELLATION OF FREE TEXT CONTENTS	
	After their printing, ALL the contents of the free texts present are cancelled.	
464	CUSTOMER DESELECTION	
	After its printing, the present customer is deselected.	
465	MATERIAL DESELECTION	
	After its printing, the present material is deselected.	
466	VEHICLE DESELECTION	
	After its printing, the present vehicle is deselected.	
	<b>NOTE: It is advisable to enter the deselection macros as last commands before the print end.</b>	
474	ONLY INPUT WEIGH DATA	GG/MM/AA
475	ONLY INPUT WEIGH TIME	HH:MM
481	PRINTS TERMINATOR	CR, CRLF, LF or NO TERMINATOR

### CALCULATOR FUNCTION

482	PRINT CALCULATED DATA	XXXXXXXXXX
483	PRINT FIRST ENTERED DATA	XXXXXXX
484	PRINTS SECOND ENTERED DATA	XXXXXXX
485	PRINTS OPERATION SYMBOL	X
	In which X is "+" in case of addition, "-" in case of subtraction, "x" in case of multiplication..	
	These blocks refer to the operation executed with the "calculator" function described in section 15.3, <b>USER MAN.REF.</b>	

### WEIGHT

301	NET WEIGHT	NET <b>bb</b> XXXXXXXXXXUM + T
	in which XXXXXXXXXXX is the weight value on 10 digits including the comma; the field expands from right to left.	
302	GROSS WEIGHT	GROSS <b>b</b> XXXXXXXXXXUM + T
303	TARE WEIGHT	TARE <b>bb</b> XXXXXXXXXXUM + T [if semiautomatic tare] PT <b>bbb</b> XXXXXXXXXXUM + T [if preset tare]
375	JUST GROSS ON 10 DIGITS	XXXXXXXXXX
376	JUST NET ON 10 DIGITS	XXXXXXXXXX
393	PRINTS FINAL WEIGHT	XXXXXXXX <b>b:bbb</b> YYYYYYYYYUM + T
	in which XXXXXXXX becomes "LOADED" if INPUT WEIGHT < OUTPUT WEIGHT or "UNLOADED" if INPUT WEIGHT > OUTPUT WEIGHT; YYYYYYYY is the difference between INPUT WEIGHT and the OUTPUT WEIGHT, including the comma.	
394	VEHICLE STORED WEIGHT	XXXXXXX: <b>bbb</b> YYYYYYYYYUM + T
	in which XXXXXXXX becomes "IN WEIGH" if an INPUT WEIGH is carried out or "OUT WEIGH" if an OUTPUT WEIGH is carried out; YYYYYYYY is the value of the first stored weight, including the comma.	
416	JUST VEHICLE WEIGHT IN INPUT	XXXXXXXX
	in which XXXXXXXX is the value of the stored input weight, including the comma.	
418	JUST WEIGHT DIFFERENCE VALUE	XXXXXXXX
	in which XXXXXXXX is the difference between the INPUT WEIGHT and the OUTPUT WEIGHT; if this difference is negative, the value with the negative sign will be printed.	
419	JUST ABSOLUTE VALUE WEIGHT DIFFERENCE	XXXXXXXX
	in which XXXXXXXX is the difference between the INPUT WEIGHT and the OUTPUT WEIGHT; the value with the negative sign will be printed.	
439	JUST 1 <sup>st</sup> OUTPUT WEIGHT	XXXXXXXX
	in which XXXXXXXX is the value of the first stored output weight, including the comma.	
441	VEHICLE WEIGHT IN INPUT	IN WEIGH: <b>bbb</b> XXXXXXXXXXUM + T
	in which XXXXXXXX is the value of the stored input weight, including the comma.	
476	PERCENT VALUE OF WEIGHT INCREMENT/DIMINUTION COMPARED WITH THE INITIAL WEIGHT	XXX.X

**NOTA:** if the printing characters are not set with 617 macro or the values are incorrect (decimal number > characters number), the percent value is always printing on 5 characters, including decimal point and one decimal number.

486 PRINTS CONDITIONED ADDITIONAL TARE +PT**bbbbbbbbb**XXXXXXXXXXUM + T  
 487 JUST ADDITIONAL TARE VALUE XXXXXXXX  
 491 ONLY AXLE NUMBER XXX

the field expands from right to left; the non significant zeros will be printed anyways.

492 ONLY ACQUIRED AXLE WEIGHT XXXXXXXXXX  
 493 ACQUIRED AXLE VALUE AXLEY**YYYbbb**XXXXXXXXXXUM + T  
 in which YYY indicates the number of axles, XXXXXXXXXX is the acquired axle value on 10 digits including the comma.

494 ONLY AXLES TOTAL WEIGHT XXXXXXXXXX  
 495 AXLES TOTAL WEIGHT TOTAL**bbbbbbb**XXXXXXXXXXUM + T  
 in which XXXXXXXX is the total axles value on 8 digits including the comma.

The following three macros print an axle list in the following format (up to a maximum of 20 axles are memorised; once this number has been exceeded, the first ones memorised are overwritten:

496 PRINTS THE LIST OF THE AXLES IN INPUT AXLEY**YYYbbb**XXXXXXXXXXUM + T  
 497 PRINTS THE LIST OF THE AXLES IN OUTPUT AXLEY**YYYbbb**XXXXXXXXXXUM + T  
 498 PRINTS THE LIST OF THE ACQUIRED AXLES AXLEY**YYYbbb**XXXXXXXXXXUM + T  
 499 PRINTS THE TOTAL NET WEIGHT ONLY XXXXXXXXXX  
 500 PRINTS "NET", TOTAL NET AND UNIT NET**bbbbbbb**XXXXXXXXXXUM + T  
 506 ONLY VEHICLE SPEED VALUE XXXXXXXX  
 507 VEHICLE SPEED VALUE SPEED**bbbbbbb**XXXXXXXXXXkm/h  
 508 OUT OF RANGE SPEED SPEED OUT OF RANGE

**PARTIAL TOTAL**

304 NET PARTIAL TOTAL N.YYY**t**1.N.XXXXXXXXX**b**UM  
 in which YYY shows the number of weighs, XXXXXXXX the weight value in 8 digits including the comma.  
 384 JUST WEIGHS PARTIAL TOTAL XXXXXXXX  
 385 JUST NET PARTIAL TOTAL XX...X

**GENERAL TOTAL**

305 NET GENERAL TOTAL N.YYY**t**2.N.**b**XXXXXXXX**b**UM + T  
 370 JUST GENERAL TOTAL WEIGHS XXXXXXXX  
 the field expands from right to left with many spaces for completing the field length.  
 371 JUST NET GENERAL TOTAL XX...X

**GRAND TOTAL**

306 NET GRAND TOTAL N.YYY**t**3.N.**b**XXXXXXXX**b**UM + T  
 386 JUST WEIGHS GRAND TOTAL XXXXXXXX  
 387 JUST NET GRAND TOTAL XX...X

**CUSTOMER**

310 JUST 1<sup>st</sup> CUSTOMER CONDITIONED DESCRIPTION XXXXXXXXXXXXXXXXXXXXXXXXXXXX + T  
 in which XXXXXXXXXXXXXXXXXXXX are the 25 description characters; just the entered characters are printed, expanding from left to right. This block can be printed only once, in input or in output.  
 311 JUST 2<sup>nd</sup> CUSTOMER CONDITIONED DESCRIPTION XXXXXXXXXXXXXXXXXXXXXXXXXXXX + T  
 in which XXXXXXXXXXXXXXXXXXXX are the 25 description characters; just the entered characters are printed, expanding from left to right. This block can be printed only once, in input or in output.  
 316 JUST CUSTOMER WEIGHS XXXXX + T  
 in which XXXXX is the number of the weighs totals relative to the selected customer.  
 383 NET CUSTOMER TOTAL N.YYY**t**C.N.XXXXXXXXX**b**UM + T  
 in which YYY indicates the number of weighs, XXXXXXXX is the weight value on 8 digits including the comma.  
 388 PRINTS CONDITIONED CUSTOMER XXXXXXXXXXXXXXXXXXXX + T  
 XXXXXXXXXXXXXXXXXXXX + T

XXXXXXXXXXXXXXXXXXXXX + T  
 in which XXXXXXXXXXXXXXXXXXXX are the 25 description characters; just the entered characters are printed, expanding from left to right. With a null description, just the terminator is printed. This block can only be printed once, either in input or in output.

396 ENTERED TOTAL CUSTOMER IN.bTOTALb:BXxxxxxxxUM + T  
 in which xxxxxxxx is the total of the UNLOADED weight relative to the selected customer.

397 EXITED TOTAL CUSTOMER OUT.bTOTALbb:bxxxxxxxxUM + T  
 in which xxxxxxxx is the total of the LOADED weight relative to the selected customer.

400 NET TOTAL CUSTOMER NETbTOTALb:bxxxxxxxxUM + T  
 in which xxxxxxxx is the difference between the ENTERED TOTAL and the EXITED TOTAL relative to the selected customer.

432 JUST 1<sup>st</sup> HEADING CONDITIONED ON CUSTOMER DESCRIPTION1  
 433 JUST 2<sup>nd</sup> HEADING CONDITIONED ON CUSTOMER DESCRIPTION2  
 435 JUST 1<sup>st</sup> DESCRIPTION ON CUSTOMER XXXXXXXXXXXXXXXXXXXXXXXX  
 in which XXXXXXXXXXXXXXXXXXXX are the 25 description characters; just the entered characters are printed, expanding from left to right; if the material is not selected, the block is ignored. The block can be printed several times, either in input or in output.

436 JUST 2<sup>nd</sup> DESCRIPTION ON CUSTOMER XXXXXXXXXXXXXXXXXXXXXXXX  
 in which XXXXXXXXXXXXXXXXXXXX are the 25 description characters; just the entered characters are printed, expanding from left to right; if the material is not selected, the block is ignored. The block can be printed several times, either in input or in output.

452 NUMBER OF SELECTED CUSTOMER MEMORY STORAGE XXX  
 the field is expressed on three digits, with some zeros to complete the length of the field.  
**NOTE:** if the customer is not selected, the block is ignored.

488 JUST 3<sup>rd</sup> CUSTOMER CONDITIONED DESCRIPTION XXXXXXXXXXXXXXXXXXXXXXXX + T  
 in which XXXXXXXXXXXXXXXXXXXX are the 25 description characters; just the entered characters are printed, expanding from left to right. This block can be printed only once, in input or in output.

489 JUST 3<sup>rd</sup> HEADING CONTINGENT ON CUSTOMER DESCRIPTION3  
 490 JUST 3<sup>rd</sup> CUSTOMER DESCRIPTION XXXXXXXXXXXXXXXXXXXXXXXX  
 in which XXXXXXXXXXXXXXXXXXXX are the 25 description characters; just the entered characters are printed, expanding from left to right; if the material is not selected, the block is ignored. The block is printed only once, either in input or output.

<b>MATERIAL</b>
-----------------

317 JUST MATERIAL WEIGHS XXXXX + T  
 in which xxxxx is the number of the weighs totals relative to the selected material.

391 PRINTS CONDITIONED MATERIAL MATERIALb:XXXXXXXXXXXXXXXXXXXXX  
 in which XXXXXXXXXXXXXXXXXXXX are the 20 description characters; ; just the entered characters are printed, expanding from left to right. The block can just be printed once, either in input or in output.

398 ENTERED TOTAL MATERIAL IN.bTOTALb:bxxxxxxxxUM + T  
 in which xxxxxxxx is the total of the UNLOADED weight relative to the selected material.

399 EXITED TOTAL MATERIAL OUT.bTOTALbb:bxxxxxxxxUM + T  
 in which xxxxxxxx is the total of the LOADED weight relative to the selected material.

401 NET TOTAL MATERIAL NETbTOTALb:bxxxxxxxxUM + T  
 in which xxxxxxxx is the difference between the ENTERED TOTAL and the EXITED TOTAL relative to the selected material.

428 JUST 1<sup>st</sup> MATERIAL CONDITIONED DESCRIPTION XXXXXXXXXXXXXXXXXXXXXXXX + T  
 in which XXXXXXXXXXXXXXXXXXXX are the 20 description characters; only the entered characters are printed, expanding from left to right. The block is printed only once, either in input or output.

429 JUST 1<sup>st</sup> MATERIAL CONDITIONED HEADING DESCRIPTION1  
 434 JUST 1<sup>st</sup> MATERIAL DESCRIPTION XXXXXXXXXXXXXXXXXXXXXXXX  
 in which XXXXXXXXXXXXXXXXXXXX are the 20 description characters; just the entered characters are printed, expanding from left to right; if the material is not selected, the block is ignored. The block can be printed several times, either in input or in output.

451 NUMBER OF SELECTED MATERIAL MEMORY STORAGE XXX

the field is expressed on three digits, with some zeros to complete the length of the field.

**NOTE:** if the material is not selected, the block is ignored.

477 JUST 2<sup>nd</sup> MATERIAL CONDITIONED DESCRIPTION XXXXXXXXXXXXXXXXXXXX + T  
 in which XXXXXXXXXXXXXXXXXXXX are the 20 description characters; only the entered characters are printed, expanding from left to right. The block is printed only once, either in input or output.

478 JUST 2<sup>nd</sup> MATERIAL CONDITIONED HEADING DESCRIPTION2

479 JUST 2<sup>nd</sup> MATERIAL DESCRIPTION XXXXXXXXXXXXXXXXXXXX  
 in which XXXXXXXXXXXXXXXXXXXX are the 20 description characters; just the entered characters are printed, expanding from left to right; if the material is not selected, the block is ignored. The block can be printed several times, either in input or in output.

<b>VEHICLE</b>	
----------------	--

312 JUST VEHICLE CONDITIONED PLATE XXXXXXXXXXXX + T  
 In which XXXXXXXXXXXX are the 10 plate characters; just the entered characters are printed, expanding from left to right. The block may be printed only once, either in input or in output.

389 PRINTS CONDITIONED PLATE PLATEb:XXXXXXXXXX  
 in which XXXXXXXXXXXX are the 10 description characters; just the entered characters are printed, expanding from left to right. With a null description, just the terminator is printed. The block can just be printed once, either in input or in output.

390 PRINTS SELECTED VEHICLE TARE PTbbbbbbbbbbbbXXXXXXXXXUM + T  
 in which XXXXXXXX is the weight value on 8 digits including the comma. The block can just be printed once, either in input or in output.

411 JUST TARE VALUE XXXXXXXX  
 in which XXXXXXXX is the weight value on 8 digits including the comma.

430 JUST "TARE" TEXT OF SELECTED VEHICLE TARE

431 JUST "PLATE" TEXT OF SELECTED VEHICLE PLATE

437 JUST PLATE VALUE XXXXXXXXXXXX  
 if the vehicle is not selected, the block will be ignored. The block can be printed several times, either in input or in output.

438 JUST VEHICLE TARE VALUE XXXXXXXX  
 if the vehicle is not selected, the block will be ignored.

453 NUMBER OF SELECTED VEHICLE MEMORY STORAGE XXX  
 the field is expressed on three digits, with some zeros to complete the length of the field.  
**NOTE:** if the vehicle is not selected, the block is ignored.

454 ONLY VEHICLE DESCRIPTION XXXXXXXXXXXXXXXXXXXX  
 in which XXXXXXXXXXXXXXXXXXXX are the 20 description characters; only the entered characters are printed, expanding from left to right; if the vehicle is not selected, the block is ignored. The block can be printed several times, either in input or in output.

455 ONLY VEHICLE CONDITIONED DESCRIPTION XXXXXXXXXXXXXXXXXXXX + T  
 in which XXXXXXXXXXXXXXXXXXXX are the 20 description characters; only the entered characters are printed, expanding from left to right; if the vehicle is not selected, the block is ignored. The block can just be printed once, either in input or in output.

456 CONDITIONED VEHICLE VEHICLEb::XXXXXXXXXXXXXXXXXXXX + T  
 in which XXXXXXXXXXXXXXXXXXXX are the 20 description characters; only the entered characters are printed, expanding from left to right; if the vehicle is not selected, the block is ignored. The block can just be printed once, either in input or in output.

457 ONLY VEHICLE WEIGHS XXXXXX + T  
 in which XXXXX is the number of the total weighs relative to the selected vehicle.

458 ENTERED TOTAL VEHICLE IN.bTOTALb:bXXXXXXXXXUM + T  
 in which XXXXXXXX is the total of the UNLOADED weight relative to the selected vehicle.

459 EXITED TOTAL VEHICLE OUT.bTOTALbb:bXXXXXXXXXUM + T  
 in which XXXXXXXX is the total of the LOADED weight relative to the selected vehicle.

460 NET TOTAL VEHICLE NETbTOTALb:bXXXXXXXXXUM + T  
 In which XXXXXXXX is the difference between the ENTERED TOTAL and the EXITED TOTAL relative or the selected vehicle.



480 JUST PLATE VALUE XXXXXXXXXX  
 if the vehicle is not selected, the block will be ignored. The block can be printed several times, either in input or in output.

<b>JUST TEXTS</b>
-------------------

313	JUST TEXT "INCOMING TOTAL"	INCOMING TOTAL
314	JUST TEXT "OUTCOMING TOT."	OUTCOMING TOT.
315	JUST TEXT "WEIGHS TOTAL"	WEIGHS TOTAL
402	JUST "PLATE" TEXT	PLATE <b>b</b> :
403	JUST "ID" TEXT	ID <b>b</b> :
404	JUST "PT" TEXT	PT <b>b</b> :
405	JUST "CUSTOMER" TEXT	CUSTOMER <b>b</b> :
406	JUST "MATERIAL" TEXT	MATERIAL <b>b</b> :
407	JUST "CUSTOMER TOTAL" TEXT	CUSTOMER TOTAL + T
408	JUST "MATERIAL TOTAL" TEXT	MATERIAL TOTAL +
409	JUST "NET" TEXT	NET <b>b</b> :
412	JUST INPUT WEIGHT TYPE TEXT	XXXX <b>b</b> :
	in which XXXXX becomes "GROSS" if INPUT WEIGHT > OUTPUT WEIGHT or "TARE" or "PT" if INPUT WEIGHT < OUTPUT WEIGHT.	
413	JUST OUTPUT WEIGHT TYPE TEXT	XXXX <b>b</b> :
	in which XXXXX becomes "TARE" or "PT" if INPUT WEIGHT > OUTPUT WEIGHT or "GROSS" if INPUT WEIGHT < OUTPUT WEIGHT.	
414	JUST WEIGHT TYPE TEXT	XXXXXXX:
	in which XXXXXXX becomes "IN WEIGH" if an INPUT WEIGHT is carried out or "OUT WEIGH" if an OUTPUT WEIGH is carried out.	
420	JUST WEIGHT DIFFERENCE TYPE TEXT	XXXXXXXXXX
	in which XXXXXXXXX becomes "LOADED" if INPUT WEIGHT < OUTPUT WEIGHT or "UNLOADED" if INPUT WEIGHT > OUTPUT WEIGHT.	
461	JUST TEXT "VEHICLE"	VEHICLE <b>b</b> :
462	JUST TEXT "VEHICLE TOTAL"	VEHICLE TOTAL + T

<b>FREE TEXTS</b>
-------------------

321	JUST INPUT 0 TEXT HEADING	XXXXXXXXXXXXXXXXXXXX
	in which XXXXXXXXXXXXXXX are 16 characters of the input 0 text heading; just the entered characters are printed, from left to right.	
322	JUST INPUT 1 TEXT HEADING	XXXXXXXXXXXXXXXXXXXX
323	JUST INPUT 2 TEXT HEADING	XXXXXXXXXXXXXXXXXXXX
324	JUST INPUT 3 TEXT HEADING	XXXXXXXXXXXXXXXXXXXX
325	JUST INPUT 4 TEXT HEADING	XXXXXXXXXXXXXXXXXXXX
326	JUST INPUT 5 TEXT HEADING	XXXXXXXXXXXXXXXXXXXX
327	JUST INPUT 6 TEXT HEADING	XXXXXXXXXXXXXXXXXXXX
328	JUST INPUT 7TEXT HEADING	XXXXXXXXXXXXXXXXXXXX
329	JUST INPUT 8 TEXT HEADING	XXXXXXXXXXXXXXXXXXXX
330	JUST INPUT 9 TEXT HEADING	XXXXXXXXXXXXXXXXXXXX
331	JUST INPUT 10 TEXT HEADING	XXXXXXXXXXXXXXXXXXXX
332	JUST INPUT 11 TEXT HEADING	XXXXXXXXXXXXXXXXXXXX
333	JUST INPUT 12 TEXT HEADING	XXXXXXXXXXXXXXXXXXXX
334	JUST INPUT 13 TEXT HEADING	XXXXXXXXXXXXXXXXXXXX
335	JUST INPUT 14 TEXT HEADING	XXXXXXXXXXXXXXXXXXXX
336	JUST THE INPUT 0 TEXT CONTENTS	YYYYYYYYYYYYYYYYYYYYYYYYYYYYYYYYYYYY
	in which YYYYYYYYYYYYYYYYYYYYYYYYYYYYYYYYY are 32 characters of the input 0 text contents; just the entered characters are printed, from left to right.	
337	JUST THE INPUT 1 TEXT CONTENTS	YYYYYYYYYYYYYYYYYYYYYYYYYYYYYYYYYYYY
338	JUST THE INPUT 2 TEXT CONTENTS	YYYYYYYYYYYYYYYYYYYYYYYYYYYYYYYYYYYY
339	JUST THE INPUT 3 TEXT CONTENTS	YYYYYYYYYYYYYYYYYYYYYYYYYYYYYYYYYYYY

```

340 JUST THE INPUT 4 TEXT CONTENTS YYYYYYYYYYYYYYYYYYYYYYYYYYYYYYYYYYYY
341 JUST THE INPUT 5 TEXT CONTENTS YYYYYYYYYYYYYYYYYYYYYYYYYYYYYYYYYYYY
342 JUST THE INPUT 6 TEXT CONTENTS YYYYYYYYYYYYYYYYYYYYYYYYYYYYYYYYYYYY
343 JUST THE INPUT 7 TEXT CONTENTS YYYYYYYYYYYYYYYYYYYYYYYYYYYYYYYYYYYY
344 JUST THE INPUT 8 TEXT CONTENTS YYYYYYYYYYYYYYYYYYYYYYYYYYYYYYYYYYYY
345 JUST THE INPUT 9 TEXT CONTENTS YYYYYYYYYYYYYYYYYYYYYYYYYYYYYYYYYYYY
346 JUST THE INPUT 10 TEXT CONTENTS YYYYYYYYYYYYYYYYYYYYYYYYYYYYYYYYYYYY
347 JUST THE INPUT 11 TEXT CONTENTS YYYYYYYYYYYYYYYYYYYYYYYYYYYYYYYYYYYY
348 JUST THE INPUT 12 TEXT CONTENTS YYYYYYYYYYYYYYYYYYYYYYYYYYYYYYYYYYYY
349 JUST THE INPUT 13 TEXT CONTENTS YYYYYYYYYYYYYYYYYYYYYYYYYYYYYYYYYYYY
350 JUST THE INPUT 14 TEXT CONTENTS YYYYYYYYYYYYYYYYYYYYYYYYYYYYYYYYYYYY
351 INPUT 0 TEXT XXXXXXXXXXXXXXXXXXXXbYYYYYYYYYYYYYYYYYYYYYYYYYYYYYYYYYYY + T
in which XXXXXXXXXXXXXXXXXXXX are 16 characters of the heading and
YYYYYYYYYYYYYYYYYYYYYYYYYYYYYYYYYYY are 32 characters of the input 0 text contents, just the entered
characters are printed, from left to right.
352 INPUT 1 TEXT XXXXXXXXXXXXXXXXXXXXbYYYYYYYYYYYYYYYYYYYYYYYYYYYYYYYYYYY + T
353 INPUT 2 TEXT XXXXXXXXXXXXXXXXXXXXbYYYYYYYYYYYYYYYYYYYYYYYYYYYYYYYYYYY + T
354 INPUT 3 TEXT XXXXXXXXXXXXXXXXXXXXbYYYYYYYYYYYYYYYYYYYYYYYYYYYYYYYYYYY + T
355 INPUT 4 TEXT XXXXXXXXXXXXXXXXXXXXbYYYYYYYYYYYYYYYYYYYYYYYYYYYYYYYYYYY + T
356 INPUT 5 TEXT XXXXXXXXXXXXXXXXXXXXbYYYYYYYYYYYYYYYYYYYYYYYYYYYYYYYYYYY + T
357 INPUT 6 TEXT XXXXXXXXXXXXXXXXXXXXbYYYYYYYYYYYYYYYYYYYYYYYYYYYYYYYYYYY + T
358 INPUT 7 TEXT XXXXXXXXXXXXXXXXXXXXbYYYYYYYYYYYYYYYYYYYYYYYYYYYYYYYYYYY + T
359 INPUT 8 TEXT XXXXXXXXXXXXXXXXXXXXbYYYYYYYYYYYYYYYYYYYYYYYYYYYYYYYYYYY + T
360 INPUT 9 TEXT XXXXXXXXXXXXXXXXXXXXbYYYYYYYYYYYYYYYYYYYYYYYYYYYYYYYYYYY + T
361 INPUT 10 TEXT XXXXXXXXXXXXXXXXXXXXbYYYYYYYYYYYYYYYYYYYYYYYYYYYYYYYYYYY + T
362 INPUT 11 TEXT XXXXXXXXXXXXXXXXXXXXbYYYYYYYYYYYYYYYYYYYYYYYYYYYYYYYYYYY + T
363 INPUT 12 TEXT XXXXXXXXXXXXXXXXXXXXbYYYYYYYYYYYYYYYYYYYYYYYYYYYYYYYYYYY + T
364 INPUT 13 TEXT XXXXXXXXXXXXXXXXXXXXbYYYYYYYYYYYYYYYYYYYYYYYYYYYYYYYYYYY + T
365 INPUT 14 TEXT XXXXXXXXXXXXXXXXXXXXbYYYYYYYYYYYYYYYYYYYYYYYYYYYYYYYYYYY + T
    
```

**PROGRESSIVE NUMBERING**

```

381 TICKET PROGRESSIVE XXXXX
(progressive number that is increased with each input/output weighing cycle and upon each single weigh)
382 LOT PROGRESSIVE XXXXXX
(number of general total resettings)
    
```

**NETWORK**

```

501 NETWORK NODE ID X
502 NETWORK GROUP ID X
503 NETWORK IP ADDRESS XXX.XXX.XXX.XXX
504 SUBNET MASK XXX.XXX.XXX.XXX
505 NODE DESCRIPTION XXXXXXXXXXXXXXXXXXXX
    
```

## 8.3.2 NUMERICAL ORDER

CODE	PRINT FORMAT
300	PRINT END
301	NET WEIGHT NET <b>bbb</b> XXXXXXXXXXUM + T in which XXXXXXXXXX is the weight value on 10 digits including the comma; the field expands from right to left.
302	GROSS WEIGHT GROSS <b>b</b> XXXXXXXXXXUM + T
303	TARE WEIGHT TARE <b>bbb</b> XXXXXXXXXXUM + T [if semiautomatic tare] PT <b>bbbb</b> XXXXXXXXXXUM + T [if preset tare]
304	NET PARTIAL TOTAL N.YYY <b>t</b> 1.N.XXXXXXX <b>b</b> UM+ T in which YYY shows the number of weighs, XXXXXXXX the weight value in 8 digits including the comma.
305	NET GENERAL TOTAL N.YYY <b>t</b> 2.N. <b>b</b> XXXXXXXX <b>b</b> UM + T
306	NET GRAND TOTAL N.YYY <b>t</b> 3.N. <b>b</b> XXXXXXXX <b>b</b> UM + T
307	DOTTED LINE ----- + T
308	PRINTS 3 CRLF
309	DATE / TIME FOR DP24/DP190 <b>b</b> HH:MM <b>b</b> DD/MM/YY + T
310	JUST 1 <sup>st</sup> CUSTOMER CONDITIONED DESCRIPTION XXXXXXXXXXXXXXXXXXXXX + T in which XXXXXXXXXXXXXXXXXXXX are the 20 description characters; just the entered characters are printed, expanding from left to right. This block can be printed only once, in input or in output.
311	JUST 2 <sup>nd</sup> CUSTOMER CONDITIONED DESCRIPTION XXXXXXXXXXXXXXXXXXXXX + T in which XXXXXXXXXXXXXXXXXXXX are the 20 description characters; just the entered characters are printed, expanding from left to right. This block can be printed only once, in input or in output.
312	JUST VEHICLE CONDITIONED PLATE XXXXXXXXXXXX + T In which XXXXXXXXXX are the 10 plate characters; just the entered characters are printed, expanding from left to right. The block may be printed only once, either in input or in output.
313	JUST TEXT "INCOMING TOTAL" INCOMING TOTAL
314	JUST TEXT "OUTCOMING TOT." OUTCOMING TOT.
315	JUST TEXT "WEIGHS TOTAL" WEIGHS TOTAL
316	JUST CUSTOMER WEIGHS XXXXX + T in which XXXXX is the number of the weighs totals relative to the selected customer.
317	JUST MATERIAL WEIGHS XXXXX + T in which XXXXX is the number of the weighs totals relative to the selected material.
318	PRINTS ON PC PORT
319	PRINTS ON PRINTER PORT
320	FORCES PRINTOUT
321	JUST INPUT 0 TEXT HEADING XXXXXXXXXXXXXXXXXXXXX in which XXXXXXXXXXXXXXXXXXXX are 16 characters of the input 0 text heading; just the entered characters are printed, from left to right.
322	JUST INPUT 1 TEXT HEADING XXXXXXXXXXXXXXXXXXXXX
323	JUST INPUT 2 TEXT HEADING XXXXXXXXXXXXXXXXXXXXX
324	JUST INPUT 3 TEXT HEADING XXXXXXXXXXXXXXXXXXXXX
325	JUST INPUT 4 TEXT HEADING XXXXXXXXXXXXXXXXXXXXX
326	JUST INPUT 5 TEXT HEADING XXXXXXXXXXXXXXXXXXXXX
327	JUST INPUT 6 TEXT HEADING XXXXXXXXXXXXXXXXXXXXX
328	JUST INPUT 7TEXT HEADING XXXXXXXXXXXXXXXXXXXXX
329	JUST INPUT 8 TEXT HEADING XXXXXXXXXXXXXXXXXXXXX
330	JUST INPUT 9 TEXT HEADING XXXXXXXXXXXXXXXXXXXXX
331	JUST INPUT 10 TEXT HEADING XXXXXXXXXXXXXXXXXXXXX
332	JUST INPUT 11 TEXT HEADING XXXXXXXXXXXXXXXXXXXXX
333	JUST INPUT 12 TEXT HEADING XXXXXXXXXXXXXXXXXXXXX
334	JUST INPUT 13 TEXT HEADING XXXXXXXXXXXXXXXXXXXXX
335	JUST INPUT 14 TEXT HEADING XXXXXXXXXXXXXXXXXXXXX
336	JUST THE INPUT 0 TEXT CONTENTS YY in which YYYYYYYYYYYYYYYYYYYYYYYYYYYYYYYYYYYYY are 32 characters of the input 0 text contents; just the entered characters are printed, from left to right.

337 JUST THE INPUT 1 TEXT CONTENTS YYYYYYYYYYYYYYYYYYYYYYYYYYYYYYYYYYYY

338 JUST THE INPUT 2 TEXT CONTENTS YYYYYYYYYYYYYYYYYYYYYYYYYYYYYYYYYYYY

339 JUST THE INPUT 3 TEXT CONTENTS YYYYYYYYYYYYYYYYYYYYYYYYYYYYYYYYYYYY

340 JUST THE INPUT 4 TEXT CONTENTS YYYYYYYYYYYYYYYYYYYYYYYYYYYYYYYYYYYY

341 JUST THE INPUT 5 TEXT CONTENTS YYYYYYYYYYYYYYYYYYYYYYYYYYYYYYYYYYYY

342 JUST THE INPUT 6 TEXT CONTENTS YYYYYYYYYYYYYYYYYYYYYYYYYYYYYYYYYYYY

343 JUST THE INPUT 7 TEXT CONTENTS YYYYYYYYYYYYYYYYYYYYYYYYYYYYYYYYYYYY

344 JUST THE INPUT 8 TEXT CONTENTS YYYYYYYYYYYYYYYYYYYYYYYYYYYYYYYYYYYY

345 JUST THE INPUT 9 TEXT CONTENTS YYYYYYYYYYYYYYYYYYYYYYYYYYYYYYYYYYYY

346 JUST THE INPUT 10 TEXT CONTENTS YYYYYYYYYYYYYYYYYYYYYYYYYYYYYYYYYYYY

347 JUST THE INPUT 11 TEXT CONTENTS YYYYYYYYYYYYYYYYYYYYYYYYYYYYYYYYYYYY

348 JUST THE INPUT 12 TEXT CONTENTS YYYYYYYYYYYYYYYYYYYYYYYYYYYYYYYYYYYY

349 JUST THE INPUT 13 TEXT CONTENTS YYYYYYYYYYYYYYYYYYYYYYYYYYYYYYYYYYYY

350 JUST THE INPUT 14 TEXT CONTENTS YYYYYYYYYYYYYYYYYYYYYYYYYYYYYYYYYYYY

351 INPUT 0 TEXT XXXXXXXXXXXXXXXXXXXXbYYYYYYYYYYYYYYYYYYYYYYYYYYYYYYYYYYY + T  
 in which XXXXXXXXXXXXXXXXXXXX are 16 characters of the heading and  
 YYYYYYYYYYYYYYYYYYYYYYYYYYYYYYYYYYYY are 32 characters of the input 0 text contents, just the entered  
 characters are printed, from left to right.

352 INPUT 1 TEXT XXXXXXXXXXXXXXXXXXXXbYYYYYYYYYYYYYYYYYYYYYYYYYYYYYYYYYYY + T

353 INPUT 2 TEXT XXXXXXXXXXXXXXXXXXXXbYYYYYYYYYYYYYYYYYYYYYYYYYYYYYYYYYYY + T

354 INPUT 3 TEXT XXXXXXXXXXXXXXXXXXXXbYYYYYYYYYYYYYYYYYYYYYYYYYYYYYYYYYYY + T

355 INPUT 4 TEXT XXXXXXXXXXXXXXXXXXXXbYYYYYYYYYYYYYYYYYYYYYYYYYYYYYYYYYYY + T

356 INPUT 5 TEXT XXXXXXXXXXXXXXXXXXXXbYYYYYYYYYYYYYYYYYYYYYYYYYYYYYYYYYYY + T

357 INPUT 6 TEXT XXXXXXXXXXXXXXXXXXXXbYYYYYYYYYYYYYYYYYYYYYYYYYYYYYYYYYYY + T

358 INPUT 7 TEXT XXXXXXXXXXXXXXXXXXXXbYYYYYYYYYYYYYYYYYYYYYYYYYYYYYYYYYYY + T

359 INPUT 8 TEXT XXXXXXXXXXXXXXXXXXXXbYYYYYYYYYYYYYYYYYYYYYYYYYYYYYYYYYYY + T

360 INPUT 9 TEXT XXXXXXXXXXXXXXXXXXXXbYYYYYYYYYYYYYYYYYYYYYYYYYYYYYYYYYYY + T

361 INPUT 10 TEXT XXXXXXXXXXXXXXXXXXXXbYYYYYYYYYYYYYYYYYYYYYYYYYYYYYYYYYYY + T

362 INPUT 11 TEXT XXXXXXXXXXXXXXXXXXXXbYYYYYYYYYYYYYYYYYYYYYYYYYYYYYYYYYYY + T

363 INPUT 12 TEXT XXXXXXXXXXXXXXXXXXXXbYYYYYYYYYYYYYYYYYYYYYYYYYYYYYYYYYYY + T

364 INPUT 13 TEXT XXXXXXXXXXXXXXXXXXXXbYYYYYYYYYYYYYYYYYYYYYYYYYYYYYYYYYYY + T

365 INPUT 14 TEXT XXXXXXXXXXXXXXXXXXXXbYYYYYYYYYYYYYYYYYYYYYYYYYYYYYYYYYYY + T

366 DATE DD-MM-YY + T

367 TIME HH:MM + T

368 DATE TIME DD/MM/YYbHH:MM + T

369 FOLLOWING MACRO TERMINATOR SKIPS

370 JUST GENERAL TOTAL WEIGHS XXXXXXXX  
 the field expands from right to left with many spaces for completing the field length.

371 JUST NET GENERAL TOTAL XX...X

372 HEADING 1 XXXXXXXXXXXXXXXXXXXXXXXXXXXXXXXX  
 in which XXXXXXXXXXXXXXXXXXXX are the 24 characters of the first line of the heading; just the entered characters  
 are printed, from left to right.

373 HEADING 2 XXXXXXXXXXXXXXXXXXXXXXXXXXXXXXXX

374 HEADING 3 XXXXXXXXXXXXXXXXXXXXXXXXXXXXXXXX

375 JUST GROSS ON 10 DIGITS XXXXXXXXXX

376 JUST NET ON 10 DIGITS XXXXXXXXXX

377 PRINTS TERMINATOR CR or CRLF or NO TERMINATOR

378 PRINTS A SPACE b

379 SCALE UNIT OF MEASURE UM

380 DATABASE UNIT OF MEASURE UM

381 TICKET PROGRESSIVE XXXXX  
 (progressive number that is increased with each input/output weighing cycle and upon each single weigh)

382 LOT PROGRESSIVE XXXXXX  
 (number of general total resettings)

383 NET CUSTOMER TOTAL N.YYYbTC.N.XXXXXXXXbUM + T  
 in which YYY indicates the number of weighs, XXXXXXXX is the weight value on 8 digits including the comma.

384 JUST WEIGHS PARTIAL TOTAL XXXXXXXXX  
 385 JUST NET PARTIAL TOTAL XX...X  
 386 JUST WEIGHS GRAND TOTAL XXXXXXXXX  
 387 JUST NET GRAND TOTAL XX...X  
 388 PRINTS CONDITIONED CUSTOMER XXXXXXXXXXXXXXXXXXXXXXXX + T  
 XXXXXXXXXXXXXXXXXXXXXXXX + T  
 XXXXXXXXXXXXXXXXXXXXXXXX + T

in which XXXXXXXXXXXXXXXXXXXXXXXX are the 20 description characters; just the entered characters are printed, expanding from left to right. With a null description, just the terminator is printed. The block can just be printed once, either in input or in output.

389 PRINTS CONDITIONED PLATE PLATEb:XXXXXXXXXX  
 in which XXXXXXXXXX are the 10 description characters; just the entered characters are printed, expanding from left to right. With a null description, just the terminator is printed. The block can just be printed once, either in input or in output.

390 PRINTS SELECTED VEHICLE TARE PTbbbbbbbbbbbbXXXXXXXXXUM + T  
 in which XXXXXXXX is the weight value on 8 digits including the comma.  
 The block can just be printed once, either in input or in output.

391 PRINTS CONDITIONED MATERIAL MATERIALb:XXXXXXXXXXXXXXXXXXXXX  
 in which XXXXXXXXXXXXXXXXXXXXXXXX are the 20 description characters; ; just the entered characters are printed, expanding from left to right. The block can just be printed once, either in input or in output.

392 PRINTS WEIGH ID IDb:XXX + T  
 In which XXX is the weigh number, from 1 to 999; only the entered characters are printed, expanding from left to right.

393 PRINTS FINAL WEIGHT XXXXXXXXXb:bbbYYYYYYYYYUM + T  
 in which XXXXXXXXX becomes "LOADED" if INPUT WEIGHT < OUTPUT WEIGHT or "UNLOADED" if INPUT WEIGHT > OUTPUT WEIGHT; YYYYYYYY is the difference between INPUT WEIGHT and the OUTPUT WEIGHT, including the comma.

394 STORED VEHICLE WEIGHT XXXXXXXXb:bbbYYYYYYYYYUM + T  
 in which XXXXXXXX becomes "IN WEIGH" if an INPUT WEIGH is carried out or "OUT WEIGH" if an OUTPUT WEIGH is carried out; YYYYYYYY is the value of the first stored weight, including the comma.

396 ENTERED TOTAL CUSTOMER IN.bTOTALb:bXXXXXXXXXUM + T  
 in which XXXXXXXX is the total of the UNLOADED weight relative to the selected customer.

397 EXITED TOTAL CUSTOMER OUT.bTOTALbb:bXXXXXXXXXUM + T  
 in which XXXXXXXX is the total of the LOADED weight relative to the selected customer.

398 ENTERED TOTAL MATERIAL IN.bTOTALb:bXXXXXXXXXUM + T  
 in which XXXXXXXX is the total of the UNLOADED weight relative to the selected material.

399 EXITED TOTAL MATERIAL OUT.bTOTALbb:bXXXXXXXXXUM + T  
 in which XXXXXXXX is the total of the LOADED weight relative to the selected material.

400 NET TOTAL CUSTOMER NETbTOTALb:bXXXXXXXXXUM + T  
 in which XXXXXXXX is the difference between the ENTERED TOTAL and the EXITED TOTAL relative to the selected customer.

401 NET TOTAL MATERIAL NETbTOTALb:bXXXXXXXXXUM + T  
 in which XXXXXXXX is the difference between the ENTERED TOTAL and the EXITED TOTAL relative to the selected material.

402 JUST "PLATE" TEXT PLATEb:

403 JUST "ID" TEXT IDb:

404 JUST "PT" TEXT PTb:

405 JUST "CUSTOMER" TEXT CUSTOMERb:

406 JUST "MATERIAL" TEXT MATERIALb:

407 JUST "CUSTOMER TOTAL" TEXT CUSTOMER TOTAL + T

408 JUST "MATERIAL TOTAL" TEXT MATERIAL TOTAL +

409 JUST "NET" TEXT NETb:

410	JUST WEIGHT ID VALUE	XXX
	In which XXX is the weigh number, from 1 to 999; only the entered characters are printed, expanding from left to right.	
411	JUST TARE VALUE	XXXXXXXX
	in which XXXXXXXX is the weight value on 8 digits including the comma.	
412	JUST INPUT WEIGHT TYPE TEXT	XXXXXb:
	in which XXXXX becomes "GROSS" if INPUT WEIGHT > OUTPUT WEIGHT or "TARE" or "PT" if INPUT WEIGHT < OUTPUT WEIGHT.	
413	JUST OUTPUT WEIGHT TYPE TEXT	XXXXXb:
	in which XXXXX becomes "TARE" or "PT" if INPUT WEIGHT > OUTPUT WEIGHT or "GROSS" if INPUT WEIGHT < OUTPUT WEIGHT.	
414	JUST WEIGHT TYPE TEXT	XXXXXXX:
	in which XXXXXXXX becomes "IN WEIGH" if an INPUT WEIGHT is carried out or "OUT WEIGH" if an OUTPUT WEIGH is carried out.	
416	JUST VEHICLE WEIGHT IN INPUT	XXXXXXXX
	in which XXXXXXXX is the value of the stored input weight, including the comma.	
418	JUST WEIGHT DIFFERENCE VALUE	XXXXXXXX
	in which XXXXXXXX is the difference between the INPUT WEIGHT and the OUTPUT WEIGHT; if this difference is negative, the value with the negative sign will be printed.	
419	JUST ABSOLUTE VALUE WEIGHT DIFFERENCE	XXXXXXXX
	in which XXXXXXXX is the difference between the INPUT WEIGHT and the OUTPUT WEIGHT; the value with the negative sign will be printed.	
420	JUST WEIGHT DIFFERENCE TYPE TEXT	XXXXXXXXXX
	in which XXXXXXXXX becomes "LOADED" if INPUT WEIGHT < OUTPUT WEIGHT or "UNLOADED" if INPUT WEIGHT > OUTPUT WEIGHT.	
421	STANDARD KD PROTOCOL STRING	
422	AF0X PROTOCOL STRING	
	through the blocks 421 and 422 it is possible to print the STANDARD or AFXX serial string (see section 5.4 TRANSMISSION PROTOCOLS for the description); the terminator of the string depends on the setting of the <b>SEtuP &gt;&gt; SEriAL &gt;&gt; tErMin</b> step of the SET-UP environment (CR or CRLF or no terminator).	
423	PRINTS TERMINATOR	CR or CRLF or NO TERMINATOR
424	RELEASES PAPER FOR TM295	
425	ACTIVATES PAPER PRESENT SENSOR FOR TM295	
426	ACTIVATES TIMEOUT FOR TM295	
427	END PAGE UPSIDE DOWN FOR TM295	
	this command causes the ticket to be expelled in the insertion area.	
428	JUST 1 <sup>st</sup> MATERIAL CONDITIONED DESCRIPTION	XXXXXXXXXXXXXXXXXXXXXXXXX + T
	in which XXXXXXXXXXXXXXXXXXXX are the 20 description characters; only the entered characters are printed, expanding from left to right. The block is printed only once, either in input or output.	
429	JUST 1 <sup>st</sup> MATERIAL CONDITIONED HEADING	DESCRIPTION1
430	JUST "TARE" TEXT OF SELECTED VEHICLE	TARE
431	JUST "PLATE" TEXT OF SELECTED VEHICLE	PLATE
432	JUST 1 <sup>st</sup> HEADING CONTINGENT ON CUSTOMER	DESCRIPTION1
433	JUST 2 <sup>nd</sup> HEADING CONTINGENT ON CUSTOMER	DESCRIPTION2
434	JUST 1 <sup>st</sup> MATERIAL DESCRIPTION	XXXXXXXXXXXXXXXXXXXXXXXXX
	in which XXXXXXXXXXXXXXXXXXXX are the 20 description characters; just the entered characters are printed, expanding from left to right; if the material is not selected, the block is ignored. The block can be printed several times, either in input or in output.	
435	JUST 1 <sup>st</sup> CUSTOMER DESCRIPTION	XXXXXXXXXXXXXXXXXXXXXXXXX
	in which XXXXXXXXXXXXXXXXXXXX are the 20 description characters; just the entered characters are printed, expanding from left to right; if the material is not selected, the block is ignored. The block is printed only once, either in input or output.	
436	JUST 2 <sup>nd</sup> CUSTOMER DESCRIPTION	XXXXXXXXXXXXXXXXXXXXXXXXX
	in which XXXXXXXXXXXXXXXXXXXX are the 20 description characters; just the entered characters are printed, expanding from left to right; if the material is not selected, the block is ignored. The block can be printed several times, either in input or in output.	

437	JUST PLATE VALUE	XXXXXXXXXX
	if the vehicle is not selected, the block will be ignored. The block can be printed several times, either in input or in output.	
438	JUST VEHICLE TARE VALUE	XXXXXXXX
	if the vehicle is not selected, the block will be ignored. The block can be printed several times, either in input or in output.	
439	JUST 1 <sup>st</sup> OUTPUT WEIGHT	XXXXXXXX
	in which XXXXXXXX is the value of the first stored output weight, including the comma.	
441	VEHICLE WEIGHT IN INPUT	IN WEIGH:bbbbXXXXXXXXXUM + T
	in which XXXXXXXX is the value of the stored input weight, including the comma.	
451	NUMBER OF SELECTED MATERIAL MEMORY STORAGE	XXX
	the field is expressed on three digits, with some zeros to complete the length of the field. <b>NOTE:</b> if the material is not selected, the block is ignored.	
452	NUMBER OF SELECTED CUSTOMER MEMORY STORAGE	XXX
	the field is expressed on three digits, with some zeros to complete the length of the field. <b>NOTE:</b> if the customer is not selected, the block is ignored.	
453	NUMBER OF SELECTED VEHICLE MEMORY STORAGE	XXX
	the field is expressed on three digits, with some zeros to complete the length of the field. <b>NOTE:</b> if the vehicle is not selected, the block is ignored.	
454	ONLY VEHICLE DESCRIPTION	XXXXXXXXXXXXXXXXXXXXX
	in which XXXXXXXXXXXXXXXXXXXX are the 20 description characters; only the entered characters are printed, expanding from left to right; if the vehicle is not selected, the block is ignored. The block can be printed several times, either in input or in output.	
455	ONLY VEHICLE CONDITIONED DESCRIPTION	XXXXXXXXXXXXXXXXXXXXX + T
	in which XXXXXXXXXXXXXXXXXXXX are the 20 description characters; only the entered characters are printed, expanding from left to right; if the vehicle is not selected, the block is ignored. The block can just be printed once, either in input or in output.	
456	CONDITIONED VEHICLE	VEHICLEb:XXXXXXXXXXXXXXXXXXXXX + T
	in which XXXXXXXXXXXXXXXXXXXX are the 20 description characters; only the entered characters are printed, expanding from left to right; if the vehicle is not selected, the block is ignored. The block can just be printed once, either in input or in output.	
457	ONLY VEHICLE WEIGHS	XXXXX + T
	in which XXXXX is the number of the total weighs relative to the selected vehicle.	
458	ENTERED TOTAL VEHICLE	IN.bTOTALb:bXXXXXXXXXUM + T
	in which XXXXXXXX is the total of the UNLOADED weight relative to the selected vehicle.	
459	EXITED TOTAL VEHICLE	OUT.bTOTALbb:bXXXXXXXXXUM + T
	in which XXXXXXXX is the total of the LOADED weight relative to the selected vehicle.	
460	NET TOTAL VEHICLE	NETbTOTALb:bXXXXXXXXXUM + T
	in which XXXXXXXX is the difference between the ENTERED TOTAL and the EXITED TOTAL relative to the selected vehicle.	
461	JUST TEXT "VEHICLE"	VEHICLEb:
462	JUST TEXT "VEHICLE TOTAL"	VEHICLE TOTAL + T
463	CANCELLATION OF FREE TEXT CONTENTS	
	After their printing, ALL the contents of the free texts present are cancelled.	
464	CUSTOMER DESELECTION	
	After its printing, the present customer is deselected.	
465	MATERIAL DESELECTION	
	After its printing, the present material is deselected.	
466	VEHICLE DESELECTION	
	After its printing, the present vehicle is deselected. <b>NOTE: It is advisable to enter the deselection macros as last commands before the print end.</b>	
467	LAST TARE ON ALIBI MEMORY	XXXXXXXXXX
474	ONLY INPUT WEIGH DATA	GG/MM/AA
475	ONLY INPUT WEIGH TIME	HH/MM
476	PERCENT VALUE OF WEIGHT INCREMENT/DIMINUTION COMPARED WITH THE INITIAL WEIGHT	XXX.X

NOTA: if the printing characters are not set with 617 macro or the values are incorrect (decimal number > characters number), the percent value is always printing on 5 characters, including decimal point and one decimal number.

477 JUST 2<sup>nd</sup> MATERIAL CONDITIONED DESCRIPTION XXXXXXXXXXXXXXXXXXXX + T  
in which XXXXXXXXXXXXXXXXXXXX are the 20 description characters; only the entered characters are printed, expanding from left to right. The block is printed only once, either in input or output.

478 JUST 2<sup>nd</sup> MATERIAL CONDITIONED HEADING DESCRIPTION2

479 JUST 2<sup>nd</sup> MATERIAL DESCRIPTION XXXXXXXXXXXXXXXXXXXX  
in which XXXXXXXXXXXXXXXXXXXX are the 20 description characters; just the entered characters are printed, expanding from left to right; if the material is not selected, the block is ignored. The block can be printed several times, either in input or in output.

480 JUST PLATE VALUE XXXXXXXXXXXX  
if the vehicle is not selected, the block will be ignored. The block can be printed several times, either in input or in output.

481 PRINTS TERMINATOR CR, CRLF, LF or NO TERMINATOR

482 PRINT CALCULATED DATA XXXXXXXXXXXX

483 PRINT FIRST ENTERED DATA XXXXXXXX

484 PRINTS SECOND ENTERED DATA XXXXXXXX

485 PRINTS OPERATION SYMBOL X

In which X is "+" in case of addition, "-" in case of subtraction, "x" in case of multiplication.

The 482, 483, 484 and 485 blocks refer to the operation executed with the "calculator" function described in section **15.3, USER MAN.REF.**

486 PRINTS CONDITIONED ADDITIONAL TARE +PTbbbbbbbbXXXXXXXXXUM + T

487 JUST ADDITIONAL TARE VALUE XXXXXXXX

488 JUST 3<sup>rd</sup> CUSTOMER CONDITIONED DESCRIPTION XXXXXXXXXXXXXXXXXXXX + T  
in which XXXXXXXXXXXXXXXXXXXX are the 25 description characters; just the entered characters are printed, expanding from left to right. This block can be printed only once, in input or in output.

489 JUST 3<sup>rd</sup> HEADING CONTINGENT ON CUSTOMER DESCRIPTION3

490 JUST 3<sup>rd</sup> CUSTOMER DESCRIPTION XXXXXXXXXXXXXXXXXXXX  
in which XXXXXXXXXXXXXXXXXXXX are the 25 description characters; just the entered characters are printed, expanding from left to right; if the material is not selected, the block is ignored. The block is printed only once, either in input or output.

491 ONLY AXLE NUMBER XXX  
the field expands from right to left; the non significant zeros will be printed anyways.

492 ONLY ACQUIRED AXLE WEIGHT XXXXXXXXXXXX

493 ACQUIRED AXLE VALUE AXLEYYYbbbbXXXXXXXXXUM + T  
in which YYY indicates the number of axles, XXXXXXXXXXXX is the acquired axle value on 10 digits including the comma.

494 ONLY AXLES TOTAL WEIGHT XXXXXXXXXXXX

495 AXLES TOTAL WEIGHT TOTALbbbbbbbbXXXXXXXXXUM + T  
in which XXXXXXXX is the total axles value on 8 digits including the comma.

The following three macros print an axle list in the following format (up to a maximum of 20 axles are memorised; once this number has been exceeded, the first ones memorised are overwritten:

496 PRINTS THE LIST OF THE AXLES IN INPUT AXLEYYYbbbbXXXXXXXXXUM + T

497 PRINTS THE LIST OF THE AXLES IN OUTPUT AXLEYYYbbbbXXXXXXXXXUM + T

498 PRINTS THE LIST OF THE ACQUIRED AXLES AXLEYYYbbbbXXXXXXXXXUM + T

499 PRINTS THE TOTAL NET WEIGHT ONLY XXXXXXXXXXXX

500 PRINTS "NET", TOTAL NET AND UNIT NETbbbbbbbbXXXXXXXXXUM + T

501 NETWORK NODE ID X

502 NETWORK GROUP ID X

503 NETWORK IP ADDRESS XXX.XXX.XXX.XXX

504 SUBNET MASK XXX.XXX.XXX.XXX

505 NODE DESCRIPTION XXXXXXXXXXXXXXXXXXXX

506 ONLY VEHICLE SPEED VALUE XXXXXXXX

507 VEHICLE SPEED VALUE SPEEDbbbbbbbbXXXXXXXXkm/h

508 OUT OF RANGE SPEED SPEED OUT OF RANGE



## 8.4 BLOCKS WITH PARAMETERS

When entering the following blocks manually in a print ticket, these require that an additional numeric value be entered (specified in detail in the block's description) in order to define the print ticket which one wants to obtain.

### EXAMPLE

Entry of the 600 "PRINT n TERMINATORS" block:

- Enter the 600 block in a ticket and confirm with OK/menu.
- The indicator does not pass by the block present in the following line, but shows "P 000".
- Enter a value between 001 and 050; for values outside this interval the indicator shows "-Error-", restoring the block before entering the block 600.
- By entering a valid value, the block will print a number of terminators equal to the one previously entered.

600	PRINTS n TERMINATORS	Values valid from 001 to 050
601	PRINTS n LF CHARACTERS	Values valid from 001 to 050
602	PRINTS n TAB CHARACTERS	Values valid from 001 to 050
603	PRINTS n SPACE CHARACTERS	Values valid from 001 to 050
604	PRINTS n " _ " CHARACTERS	Values valid from 001 to 050
605	LEFT MARGIN FOR LX300	Values valid from 001 to 255
606	NET WEIGHT ON X DIGITS	Valid values in the <b>nXX</b> format
607	GROSS WEIGHT ON X DIGITS	Valid values in the <b>nXX</b> format
608	TARE WEIGHT ON X DIGITS	Valid values in the <b>nXX</b> format

in which **n** can be:

- 0 Value with decimal point and spaces
- 1 Value with decimal point and zeros in the place of spaces
- 2 Value without decimal point and zeros in the place of spaces

**XX** is the field length (maximum enterable value is 20); if the weight value is greater than the number of entered digits, the complete value is printed anyways.

#####

### EXAMPLE

With a weight value of 100.01, if one wants a length of 10 characters, in the three cases one will have:

<u>Parameter</u>	<u>Result</u>
010	100.01
110	0000100.01
210	0000010001

#####

- |     |   |                                       |
|-----|---|---------------------------------------|
| 609 | CONDITIONING THE 1 <sup>st</sup> CUSTOMER DESCRIPTION PRINTING                                    | Valid values <b>000</b> or <b>001</b> |
|     | 000 → The previous macro can be printed a second time.  |                                       |
|     | 001 → The previous macro will not be printed a second time.                                       |                                       |
|     | This macro is valid for the CONDITIONED macros which print the first description of the customer. |                                       |

#####

### EXAMPLE

Some macros are CONDITIONED, in other words, if these are printed in input, these are ignored in output; in any case it can be useful to shown also in output the data printed in input.

For example, the 310 macro would print the first description of the customer just once, therefore if it's printed in the input weigh, it will be ignored.

If one wants to print the block also in output, set the following macros in the input printout:

```
...
310 (First customer description)
609 >>> enter parameter 000
...
300 (End printout)
```





- 621 CONVERSION OF THE “.” (POINT) CHARACTER IN THE “,” (COMMA) CHARACTER  
IN THE PREVIOUS X DIGITS Values valid in the **XX** format

**NOTE: if one uses the 621 block, one should enter the block 320 “FORCES PRINTING” before the blocks that need to be converted.**

#####

**EXAMPLE**

...  
320 (Forces printing)  
301 (Net weight)  
621 >>> parameter 20 (Conversion of the “.” (point) character in the “,” (comma))

....  
The net weight value will be printed with the comma instead of with the point.

#####

- 622 PRINTING OR CLEARING INPUT TEXT CONTENTS Values valid in the **nXX** format  
This macro allows to print a part of an input text content defined in the 614 macro or to clear the contents of the input text content.

**n** can be:

0 to print;  
1 to clear.

**XX** is the number of the input text (XX = 01 to print or clear the text contents of input 0, XX=15 to print or clear the contents of the text of input 14, XX=00 to clear all the contentx of the input texts).

- 623 SETTING THE ALIGNMENT AND NUMBER OF FORMATTING CHARACTERS Values valid in the **nXX** format  
This macro, followed by 624, allows to align to the right or to the left, the contents of the following macro in regards to the defined number of characters.

**n** can be:

0 to set the alignment to the right  
1 to set the alignment to the left

**XX** is the number of formatting characters.  
See the example in the 624 macro.

- 624 SETTING THE FILLING CHARACTER OF THE FOLLOWING MACRO Values valid in the **XXX** format  
This macro allows to set the filling character of the following macro.

**XXX** corresponds to the ASCII decimal character (from 001 to 255).

#####

**EXAMPLE**

If one wants to print on the right the contents of the 336 macro (CONTENT OF THE INPUT TEXT 0) one puts the “-” character (ASCII decimal 045) as filling on the left.

The macro contains 17 characters; therefore if the print line is 24 one should set the following macros:

...  
623 >>> enter parameter 024  
624 >>> enter parameter 045  
336 (CONTENT OF THE INPUT TEXT 0)

....  
#####

- 625 CONFIRMATION “WAIT” FROM PC OR BY PRESSING OF **C** KEY Values valid in the **XXX** format



032 Customer weight total  
 033 Customer tare total  
 034 Weighs' customer total  
 035 Customer input total  
 036 Customer output total  
 037 Vehicle net total  
 038 Vehicle gross total  
 039 Vehicle tare total  
 040 Weighs' vehicle total  
 041 Vehicle input total  
 042 Vehicle output total  
 043 First output weigh  
 044 Second output weigh  
 045 First input weigh  
 046 Second input weigh  
 047 Difference input/output  
 051 First tare value  
 052 Weight tare  
 054 Switch the set value with the comparison one

627 SETS VALUE DECIMALS Values valid in the **XXX** format

in which **XXX** can be:

000 No decimal  
 001 1 decimal  
 002 2 decimals  
 003 3 decimals  
 004 4 decimals

**NOTE: if no decimals are set, the ones of the scale are used.**

628 SETS CONVERSION VALUE UNIT OF MEASURE Values valid in the **XXX** format

in which **XXX** can be:

000 g  
 001 kg  
 002 t  
 003 lb

**NOTE: if no unit of measure has been set, the one of the scale is used.**

629 PRINTS VALUE LOADED Values valid in the **nXX** format

In which **n** can be:

0 Value with decimal point and spaces  
 1 Value with decimal point and zeros in the place of spaces  
 2 Value without decimal point and zeros in the place of spaces

**XX** is the length of the field (maximum enterable value is 20); if the weight value is greater than the number of entered digits, the complete value is printed anyways.

#####

#### EXAMPLE

The scale is with three decimals and the unit of measure is the kg; one wants to print the net weight with two decimals converted in pounds, expressed in 7 digits without decimal points, with non significant zeros filling in the eventual spaces present.

One should set the following macros:

...

626 >>> enter parameter 000  
 627 >>> enter parameter 002  
 628 >>> enter parameter 003

629 >>> enter parameter 207

....

If the net weight of the scale corresponds to 2,480 kg, the printed value will be **0000547**

#####

630 SETS THE VALUE OF THE SETPOINT IN THE MACRO 626

Values valid in the **XXX** format

Parameter ON Threshold (setpoint)

=====

000 ~ 003 rL.1 ~ 4

004 ~ 015 rL.5 ~ 16

Parameter OFF Threshold (setpoint)

=====

016 ~ 019 rL.1 ~ 4

020 ~ 031 rL.5 ~ 16

633 FORCES PRINTOUT AND TIME WAIT

Values valid in the **XXX** format

Besides the force printout function, it waits also a period of time.

**XXX** Wait time (max 200dsec); for example "001" is equal to 0,1 seconds; "010" equals to 1 second.

646 EAN/UCC CHECKDIGIT ON X PREVIOUS DIGITS

Values valid in the **XX** format

647 FOLLOWING MACROS TERMINATORS SKIPS

Valori validi nella forma **XXX**

in which **XXX** can be:

001 in order to skip the terminators of all the following macros

000 in order to include the terminators of all the following macros

#####

#### EXAMPLE

...

647 >>> enter parameter 001 The following macros will be printed without terminator

301

302

303

647 >>> enter parameter 000 The following macros will be printed with the terminator

304

305

306

...

#####

648 SIMULATES THE PRESSURE OF A KEY

- 0xx simulates the pressure of the key with xx code.

- 1xx simulates the long pressure of the key with xx code.

CODE	PRESSED KEY
00	F1 key
01	F2 key
02	F3 key
03	F4 key
04	F5 key
05	F6 key
06	F7 key
07	F8 key
08	F9 key
09	F10 key
10	Numeric key '0'
11	Numeric key '1'
12	Numeric key '2'
13	Numeric key '3'
14	Numeric key '4'
15	Numeric key '5'
16	Numeric key '6'
17	Numeric key '7'
18	Numeric key '8'
19	Numeric key '9'
20	Dot key (.)
21	ZERO key
22	Fn/ENTER key
23	2nd F key
24	C key

## 649 WAIT THE PRESSURE OF A KEY

- 0xx set the visualization of WAIT message and "block" the instrument, it remain on waiting of the pressure of the key with xx code.
- 1xx "block" the instrument, it remain on waiting of the pressure of the key with xx code.

## 650 WAIT THE STATUS OF THE INSTRUMENT

- 0xx set the visualization of WAIT message and "block" the instrument, it remain on waiting of xx status.
- 1xx "block" the instrument, it remain on waiting of xx status.

## 651 SET THE LEVEL OF THE FUNCTION

0xx set the menu level of the function that one want to perform.

## 652 SET THE FUNCTION

0xx set the code of the function that one want to perform.

Example:

To execute the function 311 is necessary insert in the format the macro 645 with 003 parameter (that set the level menu level) and the macro 646 with 011 parameter (number of the function).

## 654 REDIRECTION OF THE PRINT

Values valid **000**, **001** or **002**

- 000 print on Print port
- 001 print on Pc port
- 002 print on Aux port

**Note:** parameter 255 forces printing.

## 655 ONLY AXLE WEIGHT

Values valid in the **XX** format

This macro allows to print only the weight value of the selected axle (from those that are stored).

**XX** is the number of the axle to be printed, from 00 to 20.



- 656 AXLE WEIGHT Values valid in the **XX** format  
This macro allows to print "AXLE nr.", weight, unit of measure, and terminator of the selected axle, (from those that are stored).  
**XX** is the number of the axle to be printed, from 00 to 20.
- 657 ONLY WEIGHT OF INPUT WEIGH AXLE Values valid in the **XX** format  
This macro allows to print only the weight value of the selected axle, in case of input weigh (from those that are stored).  
**XX** is the number of the axle to be printed, from 00 to 20.
- 658 WEIGHT OF INPUT WEIGH AXLE Values valid in the **XX** format  
This macro allows to print "AXLE nr.", weight, unit of measure and terminator of the selected axle, in case of input weigh, (from those that are stored).  
**XX** is the number of the axle to be printed, from 00 to 20.
- 659 ONLY AXLE WEIGHT OF OUTPUT WEIGH Values valid in the **XX** format  
This macro allows to print only weight value of the selected axle, in case of output weigh, (from those that are stored).  
**XX** is the number of the axle to be printed, from 00 to 20.
- 660 WEIGHT OF THE AXLE OUTPUT WEIGH Values valid in the **XX** format  
This macro allows to print "AXLE nr.", weight, unit of measure and terminator of the selected axle, in case of output weigh, (from those that are stored).  
**XX** is the number of the axle to be printed, from 00 to 20.

## 9. DISPLAY CUSTOMIZATION

It's possible to program the lines of the customizable display. In each line up to 22 characters can be displayed.

The print format that allows to program the customizable display is the number 99.

The terminator to be used in this format must be CR.

One can configure this format through the Dinitools™ software (for the management of the print formats, see the manual of the software).

The programming of the lines of the display can be executed by using the print macros described in the sections "LIST OF PRINT BLOCKS" and "BLOCKS WITH PARAMETERS".

# 10. ELECTRICAL SCHEMES

## 10.1 MOTHER BOARD

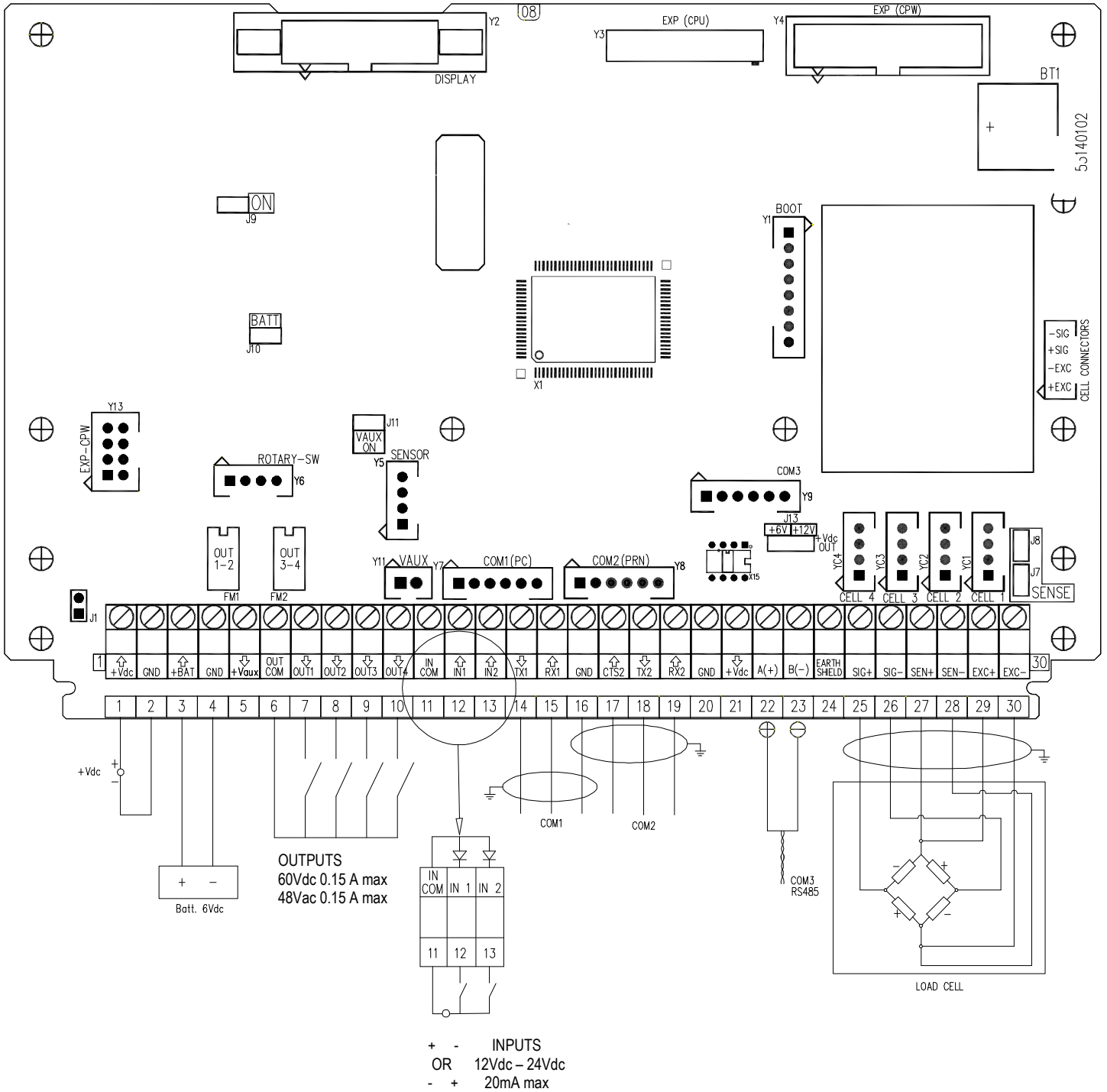

**J9 (ON):**

- If closed, one can automatically turn on the instrument as soon as the power voltage is supplied; one must also turn off the instrument by removing the mains voltage.
- If open, one can turn the instrument on and off by just pressing the ON key.

**J7, J8 (SENSE):** if closed, REFERENCE + and POWER SUPPLY +, REFERENCE - and POWER SUPPLY - are jumpered on the board

**J1:** if open, it enables the access to the metrological parameters, when configuring.

**J11 (VAUX ON):** if closed, the Vaux is always powered, independently of the “PWr.Prn” parameter of the SET-UP ENVIRONMENT.

**J13 (+Vdc OUT):** allow selecting the power voltage (+6V, +12V) of terminal board **21(+Vdc)** output.  
 By selecting **+6V** the battery must be connected on terminal 3 and 4  
 By selecting **+12V** the external power supply must be connected on terminal 1 and 2

Therefore one has to verify if the battery or the external power supply is necessary for the required output, otherwise no voltage will be supplied on the terminal 21.

### SERIAL PORTS (refer to section 5)

COM 1	COM 2	COM 3
Y7 AMP Connector: 232 serial 14-15-16 Terminal: 232 serial	Y8 AMP Connector: 232 serial 16-17-18-19 Terminal: 232 serial	Y9 AMP Connector: 232 serial 22-23 Terminal: 485 serial (with X15 integrated circuit)

### IMPORTANT:

In the case of RS485 connection, read carefully and apply what is described in chapter 5.3.

In the case of digital load cells connection, read carefully and apply what is described in chapter 2.2.

### POWER SUPPLY

6 Vdc BATTERY POWER SUPPLY	+Vdc (IN) POWER SUPPLY	V-AUX AUXILIARY POWER SUPPLY	+Vdc (OUT) POWER SUPPLY
4 GND (0 Vdc) 3 +BAT (+ 6 Vdc)	2 GND (0 V) 1 +Vdc (+12V, 8÷24 Vdc with I/O expansion board connected)	4 GND (0 V) 5 +Vaux (5,3 – 8 Vdc 400 mA max)	20 GND (0 V) 21 +Vdc (+6V or +12V, see J13 jumper description above)

### IMPORTANT:

In the case of digital load cells connection, read carefully and apply what is described in chapter 2.2.

### CELL: LOAD RECEIVER (terminal board connection)

25	<b>SIG +</b>	SIGNAL +
26	<b>SIG -</b>	SIGNAL -
27	<b>SEN +</b>	SENSE +
28	<b>SEN -</b>	SENSE -
29	<b>EXC +</b>	EXCITATION +
30	<b>EXC -</b>	EXCITATION -

### INPUTS (OPTOISOLATOR PHOTOCOUPLEDERS)

Power supply: 12 Vdc ÷ 24 Vdc, max 20 mA.

### OUTPUTS (OPTOISOLATOR PHOTOMOSFET)

Maximum power: 48 Vac or 60 Vdc, 150 mA max, 10 Ω max.

### !! IMPORTANT !!

The input/output optoisolation is obtained by feeding the input and/or output common using a voltage external the instrument.

### RS232 SERIAL PORT (RJ45 CONNECTOR) (\*)

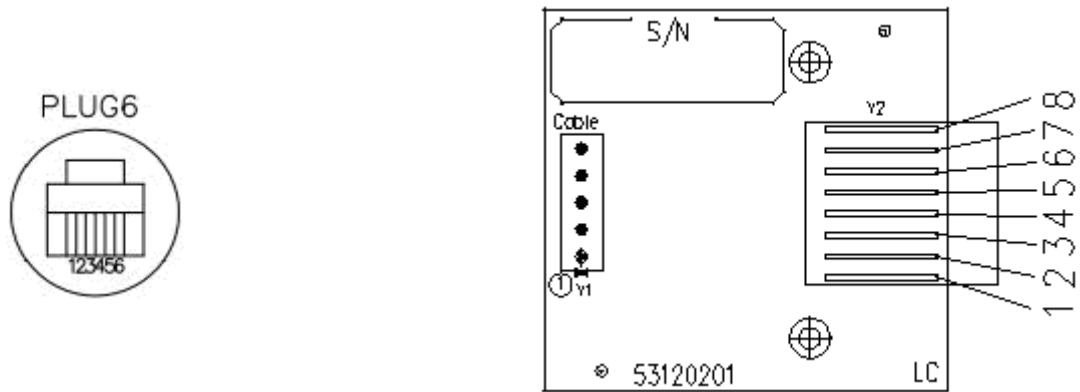
**PLUG6 CONNECTIONS:**

Y2	PLUG6	DB9	COLOUR	MEANING
1				
2	1		ORANGE-WHITE	
3	2	3	BLUE-WHITE	RX
4	3		BROWN	
5	4	5	GREEN-WHITE	GND
6	5	2	ORANGE	TX
7	6		WHITE-BROWN	
8				

(\*) May be present depending on the model.

### 10.2 I/O EXPANSION BOARD (fitted with 3590EXT in IO version or CPWE)

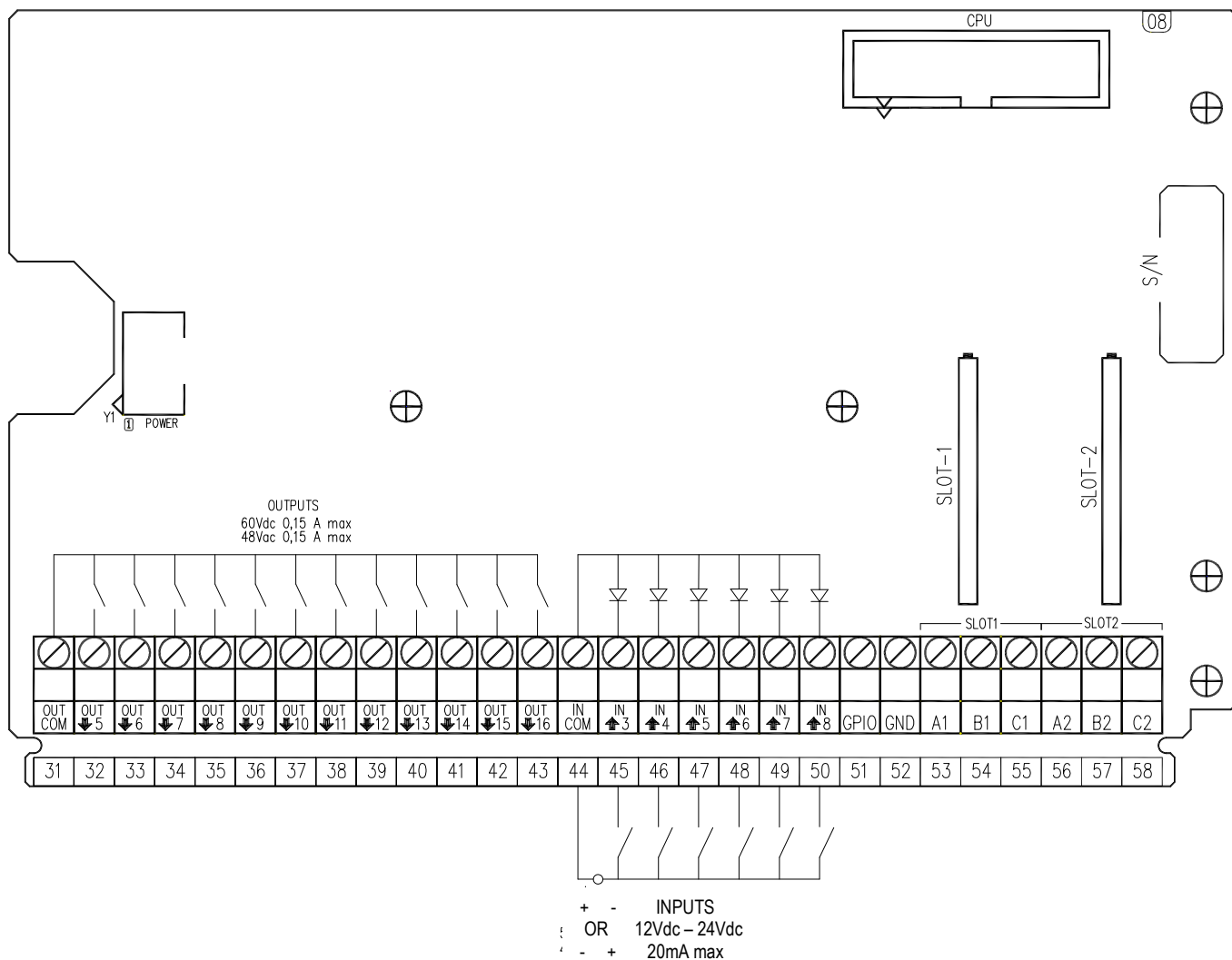

#### ANALOGUE OUTPUT

I/O1 (SLOT 1):			I/O2 (SLOT 2):		
53	I+ (A1)	+ 20 mA	56	I+ (A2)	+ 20 mA
54	COM- (B1)	0 mA / V	57	COM- (B2)	0 mA / V
55	V+ (C1)	+ 10 V	58	V+ (C2)	+ 10 V

**Note:** the maximum resistance applicable on the analogue output configured in current is 350 Ω and the minimum resistance applicable on the analogue output configured in voltage is 10 kΩ.

#### INPUTS (OPTOISOLATOR PHOTOCOUPLEDERS)

Power supply: 12 Vdc ÷ 24 Vdc, max 20 mA.

#### OUTPUTS (OPTOISOLATOR PHOTOMOSFET)

Maximum power: 48 Vac or 60 Vdc, 150 mA max, 10 Ω max.

#### !! IMPORTANT !!

The input/output optoisolation is obtained by feeding the input and/or output common using a voltage external the instrument.

### 10.3 DISPLAY BOARD

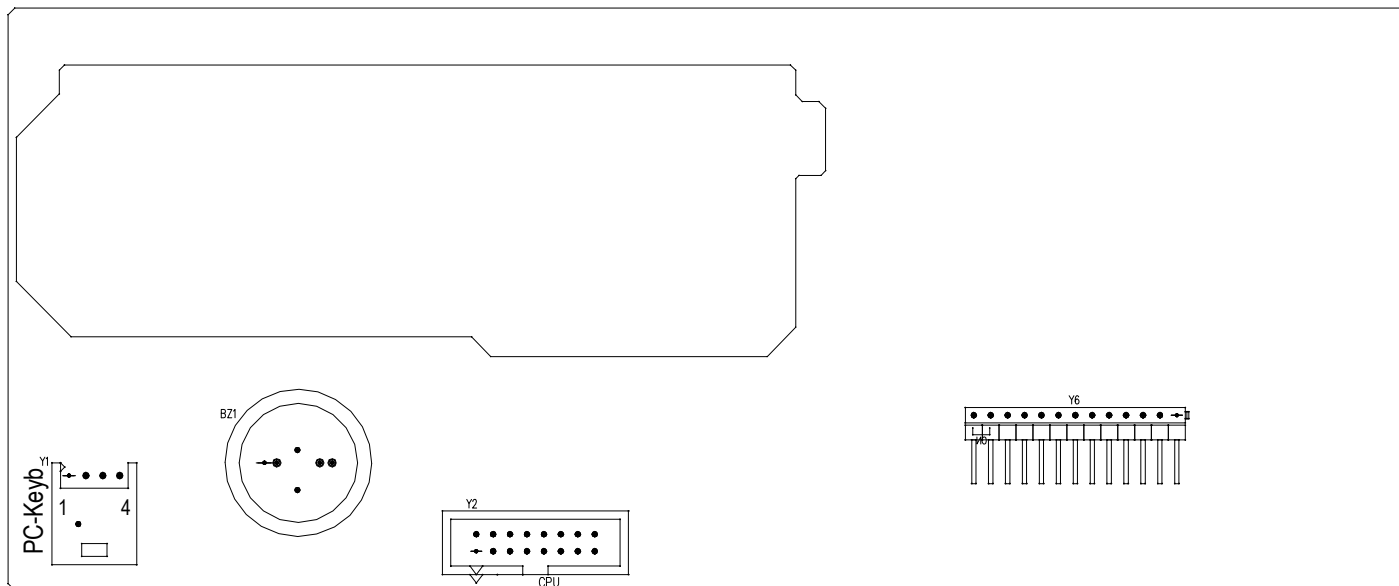

#### PC-Keyb – PC KEYBOARD CONNECTOR

Keyboard emulation input, usable for the connection of the instrument to the PC keyboard or the badge/bar code reader.

PC-KEYB		PS/2
1	+5V	4
2	GND	3
3	DATA	1
4	CLK	5

### 10.4 CONTROL LIGHT

(only for CPWET)

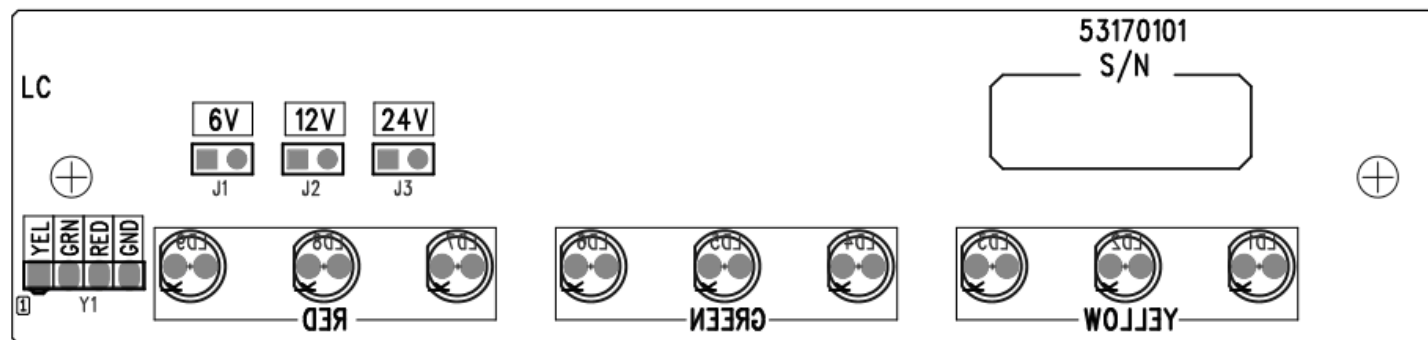

**J1:** if closed, allows to set the power supply of the control light to **6V**.

**J2:** if closed, allows to set the voltage of the control light to **12V**.

**J3:** not used

**!!WARNING!!**

**Only one jumper must be closed at time**

Y1	MEANING	COLOUR	MOTHERBOARD
1 (YEL)	OUT1	YELLOW	7
2 (GRN)	OUT2	GREEN	8
3 (RED)	OUT3	BROWN	9
4 (GND)	GND	WHITE	20